

TURNING INFORMATION INTO PROFITS

Product Portfolio

Technical Catalogue & Software Solutions

2021 EDITION

October 2020



METOS[®]

Stations & Dataloggers

10

16

18

20

24

30

36

42

48

54

60

64

68

74

78

80

Sensors

86

92

98

104

110

114

124

138

140

148

150

154

Software & Services

170

172

176

178

186

188

iMETOS VWS - Virtual Weather Station

MiniMETOS SOIL

LoRATH

LoRAIN

μMETOS NB-IoT

μMETOS SOIL LoRa

μMETOS CLIMA LoRa

iMETOS ECO D3

iMETOS 3.3

iMETOS ICA10 NB-IoT

iSCOUT®

CropVIEW®

iMETOS Tracker NB-IoT

iMETOS MobiLab

Dualex

iMETOS SoilGuard

Wind

Temperature

Soil temperature

Leaf

Precipitation

Soil moisture

Water

Snow

Light

Barometer

Plant

Interfaces

FieldClimate

FarmView

Planning Tools

Disease & Pest Models

Animal Welfare

API for Partners

Nested Approach to IoT Agriculture

Agriculture has changed drastically in the last two decades. And fast developing technology will continue to have a tremendous effect on the farming in the upcoming years. IoT in agriculture is gaining importance since it helps monitor multiple assets at once. But how does it work?

Nested or Holistic approach means connecting many different equipment/solutions that are strategically placed on your fields. Pessl Instruments connects all the dots, makes it easier to control your farm, so you don't have to worry about one aspect

being overlooked. This way you avoid unnecessary trips to the field, know exactly what are the conditions at any given time, make timely decision about irrigation, fertilizing, pesticide application, harvesting, and more 24/7 all year round.

For the nested approach to work, you need multiple devices to monitor multiple issues in your field and around your farm; having just one weather station cannot provide enough data to respond to everything your crops need.

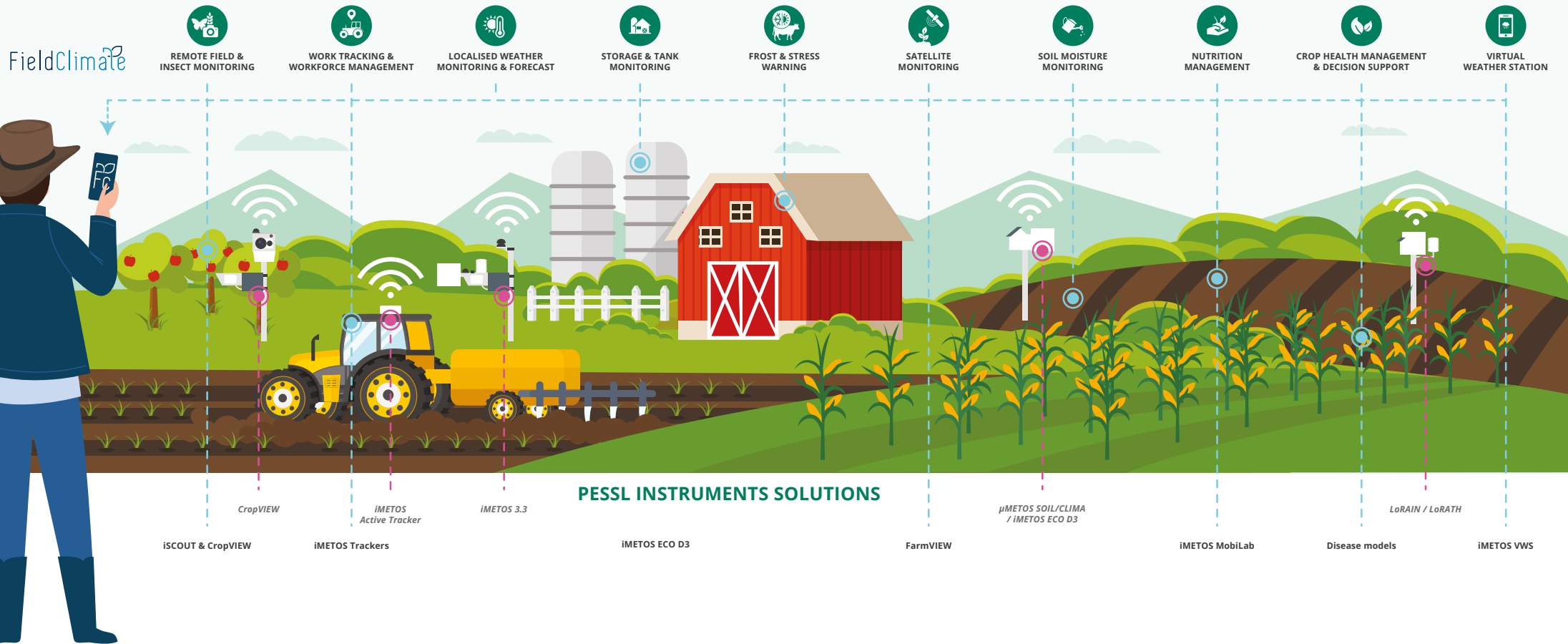

The iMETOS - Legacy Technology That Lasts

For more than 35 years, Pessl Instruments has been offering tools for informed decision-making. A complete range of wireless, solar powered monitoring systems under the iMETOS brand, and an online platform FieldClimate are applicable in all climate zones and can be used in various industries and for various purposes – from **Agriculture to Golf, Landscape, Smart City, Animal Welfare, Research, Hydrology, Meteorology, Flood Warning and more.**

Over the years, iMETOS has become a global brand with local support, and we are proud to say we managed to reach out to almost every corner of the world. We believe that durable, highly precise technology and support from our trained partners worldwide are the recipe for success.

The iMETOS brand lasts longer, performs better, is easier to use and offers you the lowest total cost of ownership.



PESSL INSTRUMENTS IN NUMBERS & FACTS:

- a global ecosystem with headquarters in Austria
- a team of **120 experts with various backgrounds** (AI specialists, Satellite experts, Plant Pathologist, Entomologists, Modellers, Hardware and Software developers, Researchers, ...)
- providing local support thanks to **16 subsidiaries** around the world
- not only manufacturers but developers as well
- over **60,000 stations** deployed worldwide
- over **500,000 sensors** connected to weather stations

INTERFACE PARTNERS



TELECOMMUNICATION PARTNERS



SENSOR PARTNERS



INPUT INDUSTRY PARTNERS





Stations & Dataloggers

iMETOS VWS - Virtual Weather Station

MiniMETOS SOIL

LoRATH

LoRAIN

μMETOS NB-IoT

μMETOS SOIL LoRa

μMETOS CLIMA LoRa

iMETOS ECO D3

iMETOS 3.3

iMETOS ICA10 NB-IoT

iSCOUT®

CropVIEW®

iMETOS Tracker NB-IoT

iMETOS MobiLab

Dualex

iMETOS SoilGuard

FAMILY NAME: Virtual Weather Station

The perfect entry point to precision agriculture. Use simulated data, calculated by highly reliable meteoblue weather models for any point on earth.

BEST USED FOR:

- Flat terrain monitoring
- No sensors = no maintenance
- Offers the same range of solutions as an actual weather station

APPLICATIONS:

Agriculture (crop growing), golf courses, parks, smart cities.

FAMILY MEMBERS: iMETOS VWS



iMETOS VWS - Virtual Weather Station

Virtual Stations exist for any point on the earth, for which meteoblue can derive weather data. The data is not the result from an actual iMETOS station measurement, but consists of simulated data, calculated by highly reliable meteoblue weather models.

In some terrains, such as flatlands, the calculated data is highly accurate with minimal discrepancies to actual values, such as temperature or precipitation. These are the regions where virtual stations prove to be a great asset.

In cases where terrain is more complex or the discrepancies to actual values are not acceptable because the risk is too high, an iMETOS station needs to be installed.

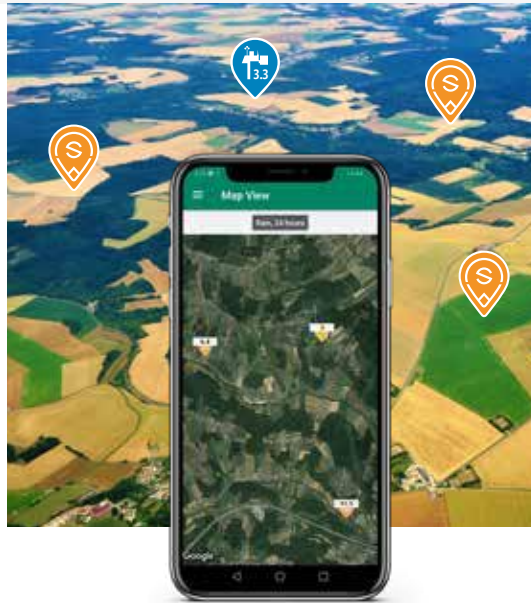

iMETOS VWS vs iMETOS IoT STATION

	Virtual station	iMETOS IoT Stations
Variables	Same parameters as iMETOS IMT300 + soil temperature	Based on sensor set
Precision	Limited	High
Availability	Anywhere in the world	Only where the station is installed
Terrain	Not complex terrain	Any terrain
Maintenance	No maintenance	Regular hardware maintenance necessary
Suitability for high value decisions (frost, water management etc.)	Limited	High

DATA QUALITY

Air temperature	
Relative humidity	
Solar radiation	
Wind speed	
Precipitation	
Leaf wetness	
Soil temperature	

With actual case studies, iMETOS VWS is under continuous improvements.

VIEW RESULTS ON OUR WEBSITE:



MAIN FEATURES

Calculated sensor variables equal to iMETOS IMT300 sensor set: wind speed, solar radiation, soil temperature, air temperature, precipitation, relative humidity and leaf wetness, along with calculated values of ET₀, vapor-pressure deficit (VPD) and Delta T. All data and decision support services are accessible online through FieldClimate platform.

THE ADVANTAGES



A perfect entry into precision agriculture with no maintenance cost

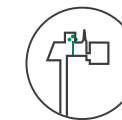

Offers the same range of solutions as an actual weather station



Very cost effective, simple to use and activated with just a few clicks on the computer or phone



Works as a complete decision support service - provides weather forecast, offers disease models and helps with work planning

FAMILY NAME: Entry Level IOTs

Compact, cost effective, small, quick to install, and designed for large-scale deployment everywhere intelligent IOTs are needed.

BEST USED FOR:

- Field operations planning (workforce allocation, spray and irrigation planning)
- Improving plant protection with disease models
- Reducing the risk for animal health problems

APPLICATIONS:

Agriculture (crop growing, animal production), golf courses, parks, smart cities, indoor monitoring, Country-wide Rainfall Networks.

FAMILY MEMBERS: MiniMETOS SOIL, LoRAIN variations & LoRATH variations



MiniMETOS SOIL



MiniMETOS SOIL is a combination of most essential sensors for irrigation and stress management.

It permanently measures soil temperature & volumetric water content (VWC) with Pessl Instruments Soil Moisture Sensor PI54-D and Watermark (soil moisture suction) in near real-time wherever you want. The installation of a logger can be completely underground (invisible); therefore, it is a perfect installation for golf courses, parks, home & garden, as well as in agriculture where vandalism and theft could be a problem.

The device is battery powered with an autonomy between 1 to 2 years, and provides actionable data, such as the exact amount of moisture and the soil temperature in each inch/cm of the measurement area, to help you plan the irrigation event and to warn you about possible stress points in a timely fashion.

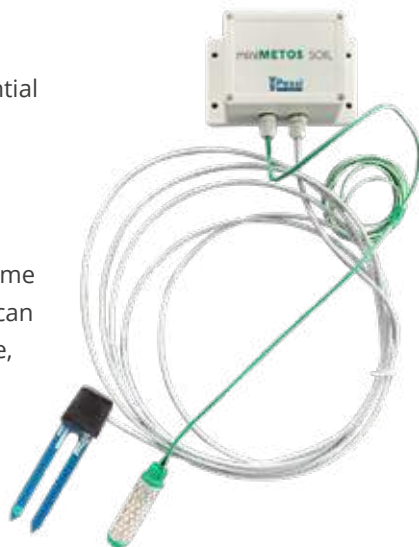

TECHNICAL SPECIFICATIONS

Housing	UV resistant polycarbonate plastic (Protection class IP67)
Dimensions	14.8 cm L x 11.8 cm W x 9.3 cm H
Weight	0.25 kg
Connectivity	NB-IoT: Category: Cat-M1/NB1 Frequency Band: B1, B2, B3, B4, B5, B8, B9, B10, B12, B13, B14, B17, B18, B19, B20, B25, B26, B27, B28, B66
Power supply	3.6V primary battery cell
Measuring interval	15 minutes
Logging interval	15 minutes
Communication interval	60 minutes
SENSORS	
PI54-D	see page 116
Watermark	see page 122

With MiniMETOS SOIL all the potential issues and stress events can be identified before they occur or become visible.

KEY FEATURES:

- Permanent measurement of the soil moisture and soil temperature at any of your locations
- Invisible, so it doesn't affect the workers and the aesthetic of location (golf course, park etc.)
- No solar panel needed as fully battery powered due latest power harvesting technology
- 1-2 years of battery autonomy and quick installation
- Cost-effective and durable
- Prevents possible vandalism



INSTALLATION ON GOLF COURSE

Laying the cable - inserting the sensors in the main turf root zone.



Preparation of the irrigation box for the data logger.



Re-installing the lawn tiles to cover the sensors. 14 days later - "invisible".

LoRATH



LoRATH is a new generation of a battery powered IOT data logger that operates on LoRaWAN™ or NB-IoT network. It can be connected to any existing LoRaWAN™ or NB-IoT network, if present at your location. LoRATH measures air temperature, relative humidity and soil moisture. All the data is synchronized with FieldClimate. The unit is prepared to be mounted inside (tunnels, greenhouses, indoor applications) or outside in open fields (IP65 protects it from water).



TECHNICAL SPECIFICATIONS

Housing	UV resistant polycarbonate plastic (Protection class IP65)	
Dimensions	14.8 cm L x 11.8 cm W x 9.3 cm H	
Weight	0.25 kg	
	LoRaWAN™	NB-IoT
Connectivity	EU863-870 or US902-928 or AU915-928 or AS923	Category: Cat-M1/NB1 Frequency Band: B1, B2, B3, B4, B5, B8, B9, B10, B12, B13, B14, B17, B18, B19, B20, B25, B26, B27, B28, B66
Power supply	Super capacitor charged with the solar panel	3.6V primary battery cell
Measuring interval	5 minutes	15 minutes
Logging interval	15 minutes	15 minutes
Communication interval	15 minutes	60 minutes
SENSORS		
Air Temperature	Operating temperature range: -40 °C to +125 °C Thermometer error -10 °C to +85 °C: +/- 0.3 °C	
Relative humidity	Precision 0 - 80 %: +/- 2 %; Precision 80 - 100 %: +/- 3 %	

Product Variations



LoRATH

Air temperature, air humidity and calculated sensors: dew point, VPD and Delta T.



LoRATH SOIL

Air temperature, air humidity, soil moisture and calculated sensors: dew point, VPD and Delta T.

By using the proprietary intelligent sensor handling, LoRATH provides additional values of:

- VPD and Delta T for defining best weather for spraying (plant protection window),
- Dew point for frost prediction.



LoRAIN



LoRAIN is a new generation of weather stations that operates on LoRaWAN™ or NB-IoT network. It can be connected to any existing LoRaWAN™ or NB-IoT network, if present at your location. LoRAIN measures rainfall, air temperature, relative humidity and soil moisture. All the data is synchronized with FieldClimate.



TECHNICAL SPECIFICATIONS

Housing	UV resistant polycarbonate plastic (Protection class IP65)	
Dimensions	22.5 cm L x 17 cm W x 18 cm H	
Weight	1,10 kg	
	LoRaWAN™	NB-IoT
Connectivity	EU863-870 or US902-928 or AU915-928 or AS923	Category: Cat-M1/NB1 Frequency Band: B1, B2, B3, B4, B5, B8, B9, B10, B12, B13, B14, B17, B18, B19, B20, B25, B26, B27, B28, B66
Power supply	Super capacitor charged with the solar panel	3.6V primary battery cell
Measuring interval	5 minutes	15 minutes
Logging interval	15 minutes	15 minutes
Communication interval	15 minutes	60 minutes
SENSORS		
Rain Gauge	Sensitivity: 1 tip per 0.2 mm	
Air Temperature	Operating temperature range: -40 °C to +125 °C Thermometer error -10 °C to +85 °C: +/- 0.3 °C	
Relative humidity	Precision 0 - 80 %: +/- 2 %; Precision 80 - 100 %: +/- 3 %	

Product Variations



LoRAIN Rain only

Rain gauge.



LoRAIN

Rain gauge, air temperature, air humidity and calculated sensors: leaf wetness, dew point, VPD and Delta T.



LoRAIN SOIL

Rain gauge, air temperature, air humidity, soil moisture and calculated sensors: leaf wetness, dew point, VPD and Delta T.

By using the proprietary intelligent sensor handling, LoRAIN provides additional values of:

- Leaf wetness for disease forecast,
- VPD and Delta T for defining best weather for spraying (plant protection window),
- Dew point for frost prediction.

LoRATH & LoRAIN Use

THIS IS WHAT YOU CAN DO:

- Plan the work week based on a localised weather forecast for your operations site
- Plan your work day based on the actual rain and temperature data and the daily weather forecast for your field
- Plan your spray program based on disease models and prediction and check the quality of spray work online
- Plan your irrigation based on ET-crop and predicted plant water use
- Bring data directly into your management software and Operations Center via automatic interface

Precipitation shown in FieldClimate



24-hour rain map



7-day rain map

LoRATH & LoRAIN Motherboards

LoRAIN and LoRATH LoRa gen 3

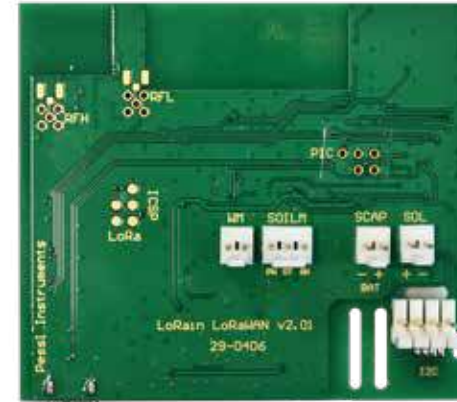

front

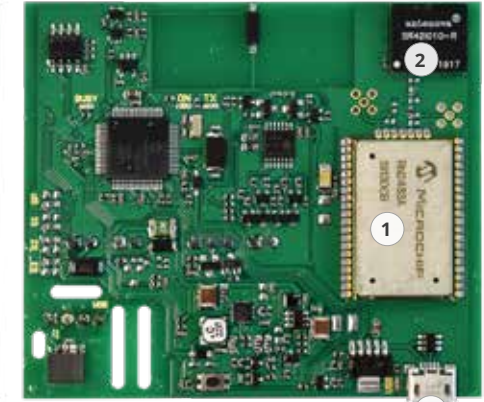

back

1. LoRaWAN™ module 2. Antenna 3. USB micro B

LoRAIN and LoRATH NB-IoT gen 3



front



back

1. NB-IoT module 2. Antenna 3. SIM card holder 4. USB micro B

FAMILY NAME: μ METOS NB-IoT

Monitor environmental parameters (rainfall, air temperature and humidity, frost, leaf wetness, solar radiation and wind speed), soil characteristics (soil moisture and soil temperature), as well as water level, water EC and pH.

BEST USED FOR:

- Soil moisture monitoring and irrigation management
- Improving plant protection with disease models
- Frost monitoring & alarms

APPLICATIONS:

Agriculture (crop growing), golf courses, parks, smart cities.

FAMILY MEMBERS: μ METOS NB-IoT variations



μMETOS NB-IoT



μMETOS NB-IoT is a LPWAN weather station that operates on NB-IoT network. It is designed to monitor basic climate parameters (rain and temperature), soil characteristics (soil moisture, soil temperature and electrical conductivity), as well as water pressure. Data is consistently measured in 15-minute intervals and sent every 60 minutes to the server. All the data is synchronized with FieldClimate.



TECHNICAL SPECIFICATIONS

Housing	UV resistant polycarbonate plastic (Protection class IP65)
Dimensions	30 cm L x 16 cm W x 19 cm H
Weight	1.6 kg
Connectivity	NB-IoT Category: Cat-M1/NB1 Frequency Band: B1, B2, B3, B4, B5, B8, B9, B10, B12, B13, B14, B17, B18, B19, B20, B25, B26, B27, B28, B66
Battery	6V charging battery with solar panel
Solar panel	Dimensions: 13.5 x 13.5 cm, 2 Watt solar panel
Measuring interval	15 minutes
Logging interval	15 minutes
Communication interval	60 minutes

Product Variations

μMETOS BASE

A basic μMETOS NB-IoT station with no physical sensors.

μMETOS FROST

Wet & Dry bulb temperature.

μMETOS DISEASE

Rain gauge, air temperature, air humidity and leaf wetness.

μMETOS FARMING

Rain gauge, air temperature, air humidity, leaf wetness and soil temperature.

μMETOS ET₀

Rain gauge, air temperature, air humidity, global radiation, wind speed.

μMETOS ET₀ FARMING

Rain gauge, air temperature, air humidity, global radiation, wind speed, soil temperature, leaf wetness.

μMETOS TUNNEL

Air temperature, air humidity, 1 x Watermark sensor, 1 x Pessl Instruments PI 54-A sensor.

μMETOS TUNNEL PLUS

PAR quantum sensor, pH + EC sensor (without electrode).

μMETOS TUNNEL COMPLETE

Air temperature, air humidity, PAR quantum sensor, pH + EC module (without electrode).

μMETOS HYDRO

Water level sensor (1 bar).

μMETOS HYDRO PLUS

Rain gauge, water level sensor (1 bar), 1 x Watermark sensors.

μMETOS NB-IoT Motherboard

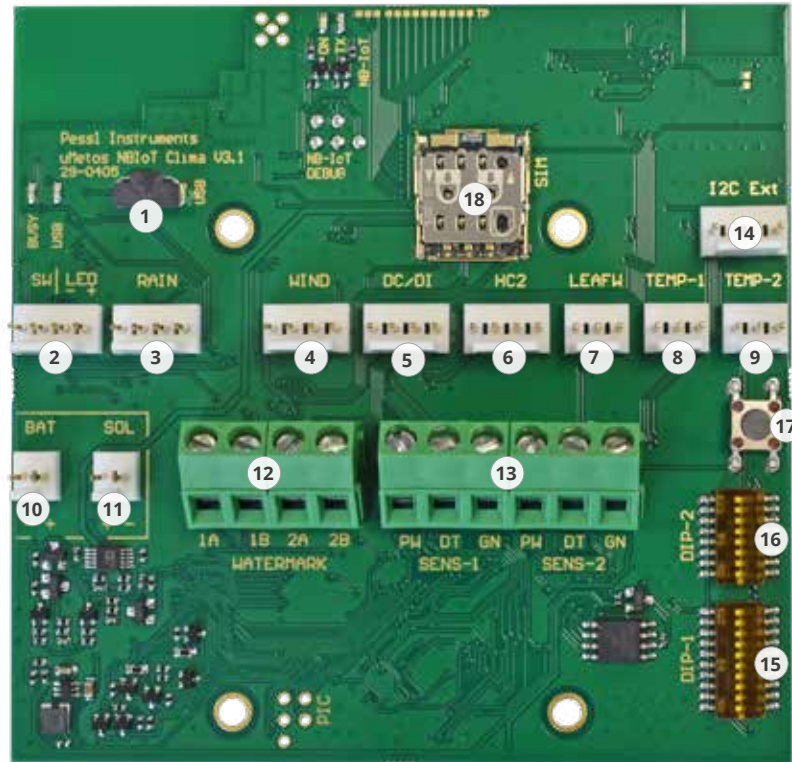

Gen. 3.1

- | | | |
|--|---------------------------------------|----------------------------|
| 1. USB micro B | 7. Leaf wetness or | or METER sensors |
| 2. External communication button with blue LED | 8. Extra temperature input | 14. I2C External connector |
| 3. Rain gauge | 9. Extra temperature input | 15. DIP-1 |
| 4. Wind speed | 10. Battery | 16. DIP-2 |
| 5. Duty cycle sensor or digital input | 11. Solar panel | 17. Connect button |
| 6. Temperature & relative humidity (Hygroclip) | 12. Connector for 2 Watermark sensors | 18. SIM card holder |
| | 13. Connector for 2 PI54-D | |



FAMILY NAME: μ METOS SOIL LoRa

Monitor basic climate parameters (rain and temperature), soil characteristics (soil moisture, soil temperature and electrical conductivity), as well as water pressure.

BEST USED FOR:

- Soil moisture monitoring and irrigation management
- Improving plant protection with disease models
- Water level monitoring

APPLICATIONS:

Agriculture (crop growing), golf courses, parks, smart cities.

FAMILY MEMBERS: μ METOS SOIL LoRa variations



μMETOS SOIL LoRa



μMETOS SOIL LoRa is a LPWAN weather station that operates on LoRaWAN™ network. It can be connected to any existing LoRaWAN™ network, if present at your location.

It is designed to monitor basic climate parameters (rain and temperature), soil characteristics (soil moisture, soil temperature and electrical conductivity), as well as water pressure.

Data is consistently measured in 5-minute intervals and sent every 15 minutes to the server. All the data is synchronized with FieldClimate.



TECHNICAL SPECIFICATIONS

Housing	UV resistant polycarbonate plastic (Protection class IP65)
Dimensions	30 cm L x 16 cm W x 19 cm H
Weight	1.6 kg
Connectivity	LoRaWAN™: EU863-870 or US902-928 or AU915-928 or AS923
Battery	6V charging battery with solar panel
Solar panel	Dimensions: 13.5 x 13.5 cm, 2 Watt solar panel
Measuring interval	5 minutes
Logging and transmission interval	15 minutes

Product Variations

μMETOS SOIL BASE LoRa

A basic μMETOS SOIL LoRa station with no physical sensors.

μMETOS SOIL RAIN LoRa

Rain gauge and soil temperature.

OPTIONAL SENSORS*

- _____ Pessl Instruments PI 54-A and PI 54-D Sensor
- _____ METER Group sensors (EC5, 10HS, MPS6, 5TE, 5TM, GS1, GS3)
- _____ Watermark Sensor
- _____ Sentek D&D Profile Sensor Probe (10 / 30 / 60 cm)
- _____ Sentek D&D Triscan Profile Sensor Probe (10 / 30 / 60 cm)
- _____ Aquacheck Sub-Surface Probe (60 / 80 / 120 cm)
- _____ Pessl Instruments EC Sensor Module
- _____ Pessl Instruments pH Sensor Module
- _____ Pressure Switch 1 Bar
- _____ Flow Meter Internal Interface Directly Connectable to Rain Sensor Input
- _____ Water level

* The number of connected sensors to a single station is limited. For specific sensor set consult with your dealer.

μMETOS SOIL LoRa Motherboard

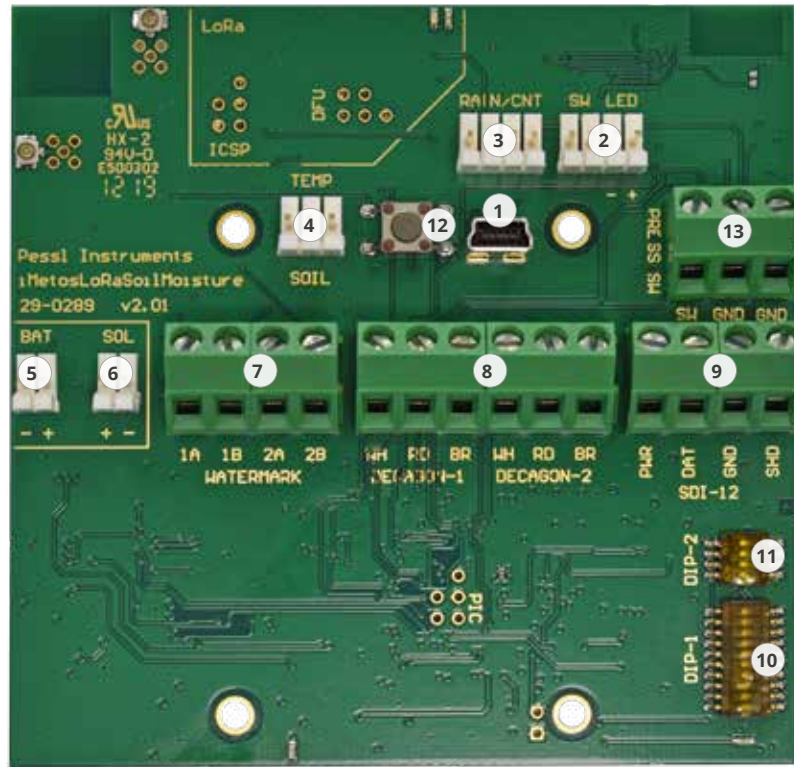

Gen. 2

- | | |
|--|--|
| 1. USB mini A | 8. Connector for 2 PI54-D or METER sensors |
| 2. External communication button with blue LED | 9. SDI12 input |
| 3. Rain gauge | 10. DIP-1 |
| 4. Soil temperature | 11. DIP-2 |
| 5. Battery | 12. Connect button |
| 6. Solar panel | 13. Pressure switch input |
| 7. Connector for 2 Watermark sensors | |



FAMILY NAME: μ METOS CLIMA LoRa

Monitor environmental parameters (rainfall, air temperature and humidity, frost, leaf wetness, solar radiation and wind speed), soil characteristics (soil moisture and soil temperature), as well as water level, water EC and pH.

BEST USED FOR:

- Soil moisture monitoring and irrigation management
- Improving plant protection with disease models
- Frost monitoring & alarms

APPLICATIONS:

Agriculture (crop growing, animal production), golf courses, parks, smart cities, hydrology

FAMILY MEMBERS: μ METOS CLIMA LoRa variations



μMETOS CLIMA LoRa



μMETOS CLIMA is a LPWAN weather station that operates on LoRaWAN™ network. It can be connected to any existing LoRaWAN™ network, if present at your location.

It is designed to monitor basic climate parameters (rain and temperature, humidity, frost, leaf wetness, solar radiation, wind speed), soil characteristics (soil moisture and soil temperature), as well as water level, water EC and pH. Data is permanently measured in 5-minute intervals and sent every 15 minutes to the server. All the data is synchronized with FieldClimate.



TECHNICAL SPECIFICATIONS

Housing	UV resistant polycarbonate plastic (Protection class IP65)
Dimensions	30 cm L x 16 cm W x 19 cm H
Weight	1.6 kg
Connectivity	LoRaWAN™: EU863-870 or US902-928 or AU915-928 or AS923
Battery	6V charging battery with solar panel
Solar panel	Dimensions: 13.5 x 13.5 cm, 2 Watt solar panel
Measuring interval	5 minutes
Logging and transmission interval	15 minutes

Product Variations

μMETOS CLIMA BASE

A basic μMETOS CLIMA LoRa station with no physical sensors.

μMETOS CLIMA FROST

Wet & Dry bulb temperature.

μMETOS CLIMA DISEASE

Rain gauge, air temperature, air humidity and leaf wetness.

μMETOS CLIMA FARMING

Rain gauge, air temperature, air humidity, leaf wetness and soil temperature.

μMETOS CLIMA ET₀

Rain gauge, air temperature, air humidity, global radiation, wind speed.

μMETOS CLIMA ET₀ FARMING

Rain gauge, air temperature, air humidity, global radiation, wind speed, soil temperature, leaf wetness.

μMETOS CLIMA TUNNEL

Air temperature, air humidity, 1 x Watermark sensor, 1 x Pessl Instruments PI 54-A sensor.

μMETOS CLIMA TUNNEL PLUS

PAR quantum sensor, pH + EC module (without electrode).

μMETOS CLIMA TUNNEL COMPLETE

Air temperature, air humidity, PAR quantum sensor, pH + EC sensor (without electrode).

μMETOS CLIMA HYDRO

Water level sensor (1 bar).

μMETOS CLIMA HYDRO PLUS

Rain gauge, water level sensor (1 bar), 1 x Watermark sensors.

μMETOS CLIMA LoRa Motherboard

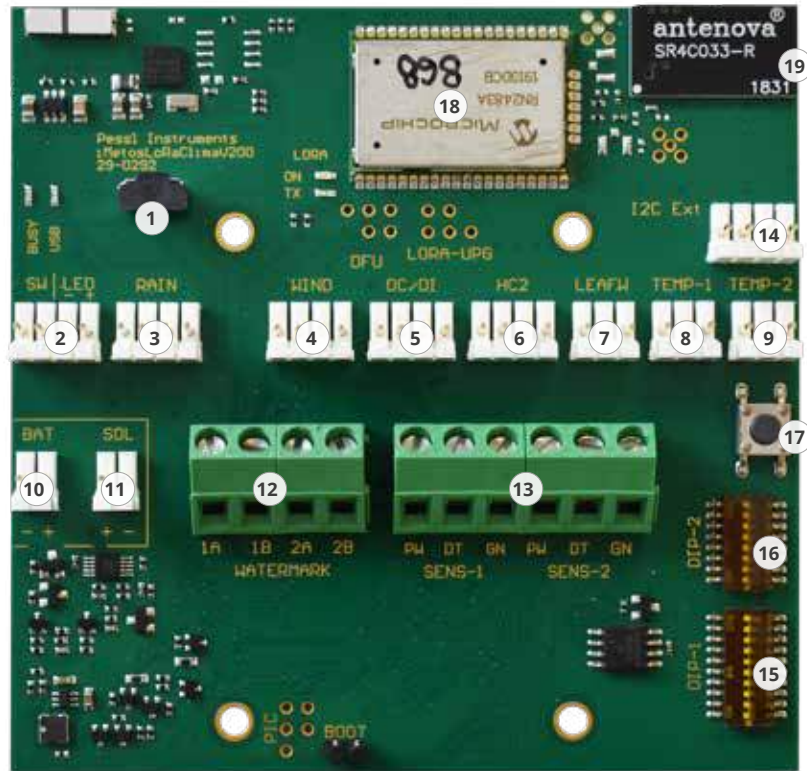

Gen. 1

- | | | |
|--|---------------------------------------|-------------------------------|
| 1. USB micro B | 7. Leaf wetness or | or METER sensors |
| 2. External communication button with blue LED | 8. Extra temperature input | 14. I2C External connector |
| 3. Rain gauge | 9. Extra temperature input | 15. DIP-1 |
| 4. Wind speed | 10. Battery | 16. DIP-2 |
| 5. Duty cycle sensor or digital input | 11. Solar panel | 17. Connect button |
| 6. Temperature & relative humidity (Hygroclip) | 12. Connector for 2 Watermark sensors | 18. LoRaWAN™ module |
| | 13. Connector for 2 PI54-D | 19. On-board LoRaWAN™ antenna |



FAMILY NAME: iMETOS ECO D3

A powerful data logger, designed to work in harsh conditions, is mainly used for basic soil moisture monitoring, irrigation management and hydrology, as well as disease modeling. Versatile, with the possibility to do extra configurations and connect up to 400 sensors.

BEST USED FOR:

- Soil moisture monitoring and irrigation management
- Frost monitoring and alarms
- Improving plant protection with disease models

APPLICATIONS:

Agriculture (crop growing, animal production), golf courses, parks, smart cities, research, hydrology

FAMILY MEMBERS: iMETOS ECO D3 variations



iMETOS ECO D3



The wireless iMETOS ECO D3 is a solar panel and battery powered data logger, designed to work in harsh conditions and in all climate zones. The system has a fully integrated LTE modem for direct communication with the FieldClimate platform and can handle up to 400 sensors through the intelligent sensor bus system.

Different sensor sets enable different kinds of monitoring - water level, soil moisture, soil salinity etc.



TECHNICAL SPECIFICATIONS

	3 fixed analogue inputs: rain gauge, temperature/relative humidity, leaf wetness, 1 temperature input
Sensors Layout	1 RS485 digital input – automatic sensor recognition supporting sensor chains 1 RS485 expansion input – supports 2 optional digital inputs
Memory	8 MB flash memory
Internet connectivity	2G, 3G, 4G (LTE class 1, LTE class M)
Alert	SMS, user configurable via website
Dimensions without sensors	30 cm L x 16 cm W x 19 cm H
Weight without sensors	1.9 kg
Measuring interval	5 minutes (by default)
Logging interval	10-120 minutes (user selectable)
Transmission frequency	User selectable
Battery	6V, 4.5AH, Operating range: -35 °C to 80 °C
Solar panel	Dimensions: 13.5 x 13.5 cm, 2 Watt solar panel
	iMETOS ECO D3 base unit (without sensors), solar panel, with main board

Main Sensor Variations

iMETOS ECO D3 FROST

The most accurate and affordable web based frost and stress warning system gives real time warning from anywhere in the world via SMS or through website with the use of Wet & Dry bulb temperature sensor. Users can easily set their own alert strategy through FieldClimate.

iMETOS ECO D3 CLIMA

Application for micro-climate monitoring and disease models.

- **iMETOS ECO D3 CLIMA 80:** rain gauge and single air temperature with convection shield.
- **iMETOS ECO D3 CLIMA 180-HC:** rain gauge, air temperature and humidity (hygroclip) with convection cap.
- **iMETOS ECO D3 CLIMA 180-PI:** rain gauge, air temperature and humidity (HYT939 sensor) with convection cap.
- **iMETOS ECO D3 CLIMA 200-HC:** rain gauge, leaf wetness, air temperature and humidity (hygroclip) with convection cap.
- **iMETOS ECO D3 CLIMA 200-PI:** rain gauge, leaf wetness, air temperature and humidity (HYT939 sensor) with convection cap.

iMETOS ECO D3 SOIL MOISTURE

Connect a wide range of OEM sensors to your station; measure soil moisture, temperature, salinity and monitor the irrigation system (flow, pressure, tank level of fertilizer).

- **iMETOS ECO D3 SM-1 (ECH871INT-RAIN):** rain gauge and internal interface for 2x PI-bus sensors/Meter group, 2x Watermark and 1x Soil temperature.
- **iMETOS ECO D3 SM-2 (SEN-SDI 12-RAIN):** rain gauge and internal interface SDI-12 for Sentek D&D, Aquacheck probe.
- **iMETOS ECO D3 SM-3 (ECH871INT):** internal interface for 2x PI-bus sensors/Meter group, 2x Watermark and 1x Soil temperature.
- **iMETOS ECO D3 SM-4 (SEN-SDI 12):** internal interface SDI-12 for Sentek D&D, Aquacheck probe.
- **iMETOS ECO D3 SM-5 (ECH870INT):** internal interface for 3x PI-bus sensors/Meter group.
- **iMETOS ECO D3 SM-6 (PSW):** PI pressure switch.
- **iMETOS ECO D3 SM-7 (SW1000):** internal interface (rain, reed input) for Water meter.
- **iMETOS ECO D3 TANK MONITOR:** PI tank level sensor.

iMETOS ECO D3 for Flood & Snow Monitoring

Pessl Instruments Ultrasonic Snow Height or Water Depth Sensor.

iMETOS ECO D3 Motherboard

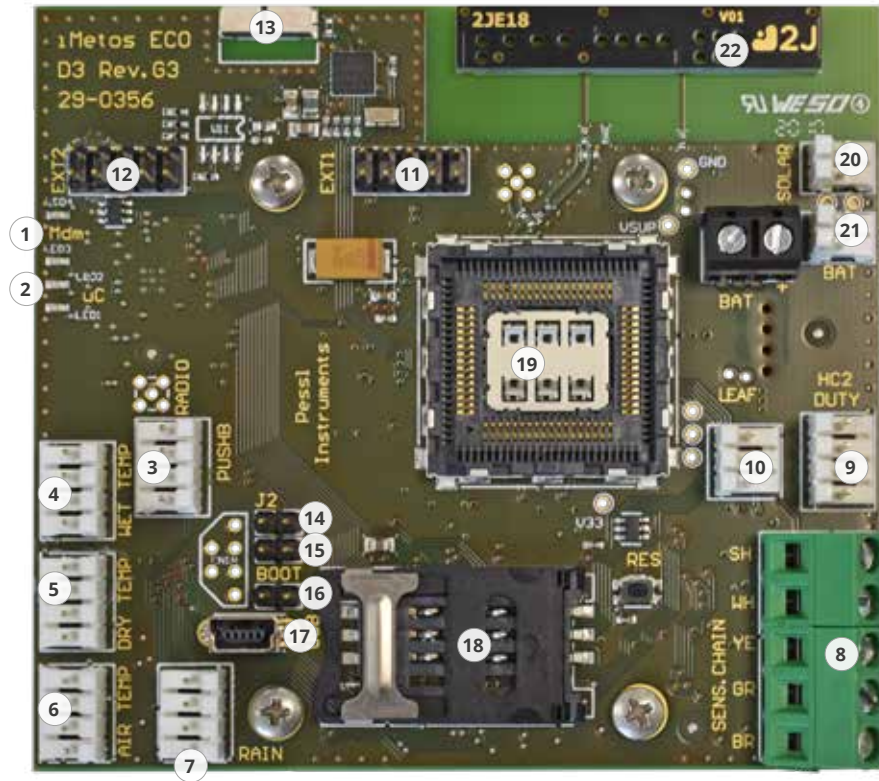

- | | | |
|--------------------------|--|------------------------------|
| 1. Modem LED | 9. Temperature & relative humidity (Hygroclip) | 16. Boot jumper |
| 2. CPU LED | 10. Leaf wetness | 17. USB |
| 3. Sensor input | 11. Extension 1 | 18. SIM card holder |
| 4. Wet temperature | 12. Extension 2 | 19. Modem |
| 5. Dry temperature | 13. Built-in GPS antenna | 20. Solar panel |
| 6. Air temperature | 14. Jumper J1 | 21. Battery |
| 7. Rain gauge | 15. Jumper J2 | 22. Built-in network antenna |
| 8. Dedicated chain input | | |



FAMILY NAME: iMETOS 3.3

A powerful, durable and flexible data logger for all climatic conditions offers a complete solution for environmental monitoring, disease models, water management and more. Versatile, with the possibility to do extra configurations and connect up to 600 sensors.

BEST USED FOR:

- Improving plant protection with disease models
- Soil moisture monitoring and irrigation management
- Frost monitoring and alarms

APPLICATIONS:

Agriculture (crop growing, animal production), golf courses, parks, smart city, research, meteorology, hydrology

FAMILY MEMBERS: IMT variations



iMETOS 3.3



A powerful, durable and flexible data logger for all climatic conditions offers a complete solution for environmental monitoring, disease models, water management and more. Versatile, with the possibility to do extra configurations and connect up to 600 sensors. Additionally, you can connect Pessl Instruments proprietary radio network (*for technical information see page 160*) and up to 16 wireless sensor nodes within a farm, research block, golf course, park, ...



TECHNICAL SPECIFICATIONS

Sensors layout	1 wind speed, 1 leaf wetness, 1 rain gauge, 1 water-meter (reed), 2 hydroclips (air temperature and relative humidity)
Extension connector	Radio access point or Sentek Drill & Drop or ultrasonic wind sensor or two extra chain connectors – Pessl Instruments bus cable nodes
Memory	8 MB flash memory
Internet connectivity	2G, 3G, 4G (LTE class 1, LTE class M), WiFi (802.11b)
Alert	SMS, user configurable via website
Dimensions without sensors	41 cm L x 13 cm W x 7 cm H
Weight without sensors	2.2 kg
Measuring interval	5 minutes (by default)
Logging interval	10-120 minutes (user selectable)
Transmission frequency	User selectable
Battery	6V, 4.5AH, Operating range: -35 °C to 80 °C
Solar panel	Dimensions: 13.5 x 13.5 cm, 2 Watt solar panel

iMETOS 3.3 base unit (no sensors included), internet based logger, battery 4.5Ah, solar panel, UMTS based, logger, mounting brackets

Main Sensor Variations

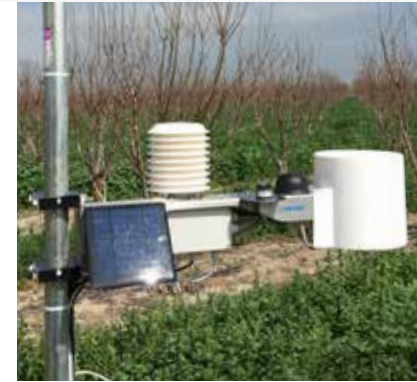

iMETOS IMT180

Air Temperature and Relative Humidity sensor and Rain Gauge.



iMETOS IMT200

Air Temperature and Relative Humidity sensor, Rain Gauge, Leaf Wetness sensor and Sensors for Disease models.



iMETOS IMT280-USW

Rain Gauge and all the sensors for Evapotranspiration calculation: Air Temperature and Relative Humidity, Global Radiation and Ultrasonic Wind.



iMETOS IMT300-USW

Sensors for Evapotranspiration and Disease Models calculation: Air Temperature and Relative Humidity, Rain Gauge, Global Radiation, Ultrasonic Wind and Leaf Wetness.

iMETOS 3.3 Motherboard

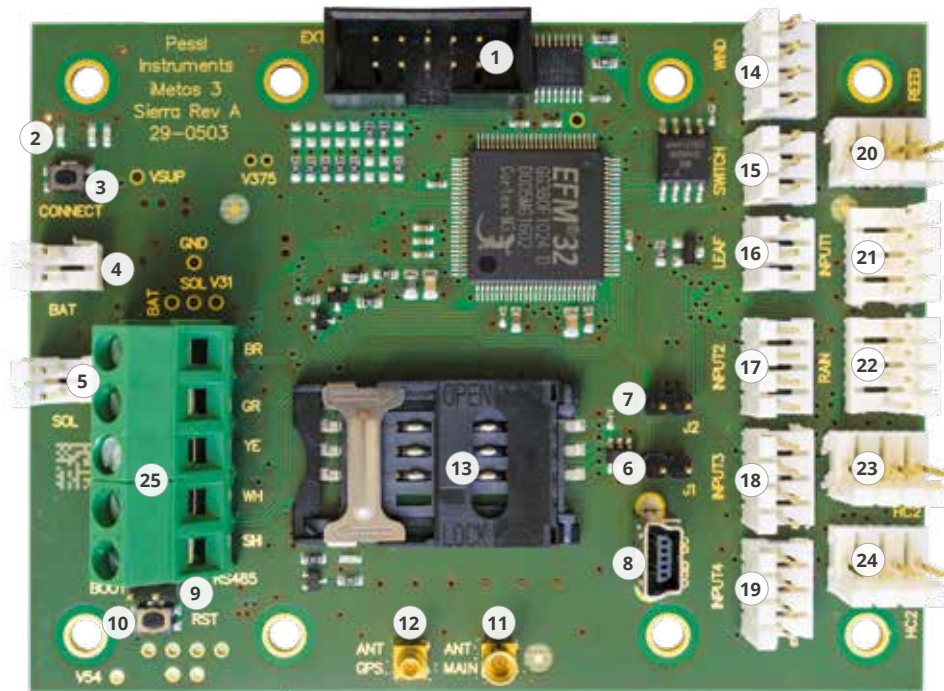

- | | | |
|------------------------------------|---------------------|--|
| 1. Extension board
(Radio node) | 10. Reset button | 20. Reed |
| 2. LED indicators | 11. GSM antenna | 21. Input 1 |
| 3. Connect button | 12. GPS antenna | 22. Rain gauge |
| 4. Battery | 13. SIM card holder | 23. Temperature & relative
humidity (Hygroclip) |
| 5. Solar panel | 14. Wind speed | 24. Temperature & relative
humidity (Hygroclip) |
| 6. Jumper J1 | 15. Switch | 25. Dedicated chain input |
| 7. Jumper J2 | 16. Leaf wetness | |
| 8. USB | 17. Input 2 | |
| 9. Boot jumper | 18. Input 3 | |
| | 19. Input 4 | |



FAMILY NAME: iMETOS ICA10 NB-IoT

A smart system which uses the data from a pressure switch to monitor and to operate the irrigation system.

BEST USED FOR:

- Optimisation of irrigation cycles
- Optimisation of fertigation cycles
- Monitoring and operating the irrigation system

APPLICATIONS:

Agriculture (crop growing), hydrology

FAMILY MEMBERS: iMETOS ICA10 NB-IoT



iMETOS ICA10 NB-IoT



iMETOS ICA10 NB-IoT is a smart system which uses the data from a flow sensor switch to monitor and operate the irrigation system.

With the help of partner platform Spherag, sensors for soil moisture, temperature, relative humidity, wind, rain, water counter, pressure transducers etc. can be used to automatically switch the solenoids.

iMETOS ICA10 NB-IoT works with most common solenoids from Baccara, TORO, Rainbird, Netafim etc. to make irrigation/fertigation cycles more intelligent, based on data and real plant requirements.



iMETOS ICA10 NB-IoT applications

TECHNICAL SPECIFICATIONS

Sensors Layout	Automatic ON/OFF switch, Pressure detector
Memory	Microprocessor
Internet connectivity	NB-IoT
Alert	Notification, user configurable via website Remotely operated
Weight without sensors	246.5 g
Measuring interval	Real time
Logging interval	Real time
Internet contact	Real time
Battery	3,7V, 3AH, Operating range: -15° C to 60° C
Solar panel	Dimensions: 45 x 70 cm, 0,4 Watt solar panel
Outputs	1 bi-directional Latch valves (DC) . Outcome 14V



Data in Spherag platform

FAMILY NAME: Camera products

A remote monitoring system that continuously monitors insect pressure (iSCOUT) and growth of your crops and detects problems in breeding facilities (CropVIEW).

BEST USED FOR:

- Preventing damage on crops and fields
- Reducing the use of pesticides or insecticides
- Early detection of diseases & insect pressure
- Yield forecast through AI on following crop growth

APPLICATIONS:

Agriculture (crop growing, animal production), golf courses, parks, smart city, research

FAMILY MEMBERS: iSCOUT variations & CropVIEW variations



iSCOUT® - AI-Based Insect Scouting

iSCOUT® is a combination of hardware and software solutions for remote monitoring of different pest insects. The iSCOUT® is an insect trap with integrated electronics and a sticky plate. Due to its low weight, it can be hung wherever in the field. In the field, the device is self-sufficient, as it is powered by a solar panel and a battery. 10 MP camera takes high-resolution pictures of the sticky plate within the iSCOUT® trap. Images are sent via LTE to an online platform where they are analyzed and counted with automatic pest detection framework, using AI and self-learning algorithms. All data from camera system and AI software is displayed online, on the FieldClimate platform.

Two camera devices (iSCOUT® or CropVIEW®) can be connected on one control unit. Every power unit can also host the following environmental sensors: rain, temperature and relative humidity (Hygroclip) and leaf wetness.

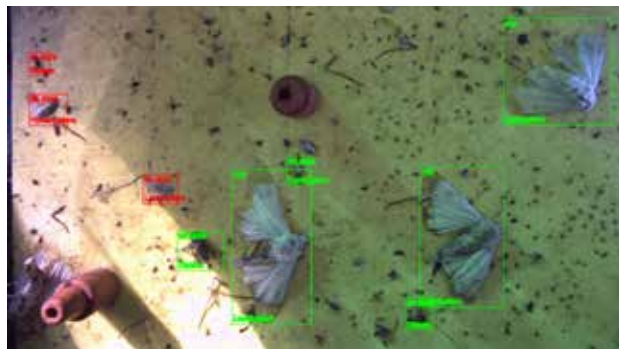

iSCOUT® uses automatic recognition algorithm for recognizing pests.

TECHNICAL SPECIFICATIONS

Memory	1 GB
Internet connectivity	LTE class 1
GPS receiver	Yes
Dimensions of trap housing without control unit	20 cm L x 15.5 cm W x 17 cm H
Weight without control unit	0.93 kg
Transmission interval	Max. 3 times per day (usually once per day)
Battery type	Rechargeable Lead acid battery 6V, 12 Ah
Solar panel dimensions	17.5 x 17.5 cm, 7.2 Volt, 333 mA
Camera	10 megapixel camera

Internet based monitoring device, solar panel, rechargeable battery, GPRS Logger, GPS sensor



iSCOUT® Color Trap

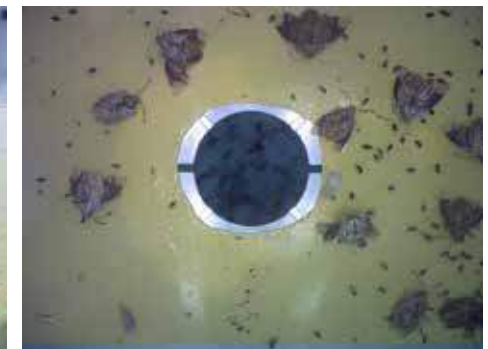

iSCOUT® Bug

iSCOUT® PHEROMONE

Designed and developed to catch insects with insect specific pheromone lure (**codling moth, european grape berry moth, tomato leafminer and many other species**). It includes a metal plate on which sticky paper and a pheromone lure can be applied.



iSCOUT® BUG

Designed and developed to catch bugs (**marmorated stink bug and others**). It includes a metal bottom plate with black pyramid wings and has closed side entries. Once the bug enters the trap from the bottom, it is fixed on the plate.

iSCOUT® FRUIT FLY

Designed and developed to catch fruit flies (**spotted wing drosophila, olive fruit fly, mediterranean fruit fly and many other species**). It includes 3 mm nettings on entries, so that bigger flies (house flies) cannot enter the trap. Tank system for lure and metal plate on which sticky paper is applied are included. To catch and monitor bigger flies, nettings can be removed.



iSCOUT® COLOR TRAP

Designed and developed to monitor sticky traps of different colors. The device comes with high resolution camera and a holder for a sticky plate.

Catching various insects depends on the color of the plate used:

- blue: **frankliniella occidentalis, thrips tabaci, ...**
- yellow: **white flies, leafminers, sciarid flies, ...**
- white: **apple sawfly, plum sawfly, plum fruit sawfly, raspberry beetle, ...**



CropVIEW® - AI-Based Crop & Growth Monitoring Solution

CropVIEW® is an agricultural information system, which periodically takes high resolution photos of farmland, research plots, crop canopies, orchards etc. Photos are automatically uploaded to FieldClimate platform, thus allowing a constant crop quality and yield control. The high resolution pictures enable checking seeds for germination, monitoring the effect of fertilizers and pesticides on crop development, and help decide whether a disease or pest already threatens profitability.

High-resolution images can be viewed and analysed daily over time without any additional effort.

The system operates with rechargeable battery and a solar panel all year round in most climatic zones.

Two camera devices (iSCOUT® or CropVIEW®) can be connected on one control unit. Every power unit can also host the following environmental sensors: rain, temperature and relative humidity (Hygroclip) and leaf wetness.



TECHNICAL SPECIFICATIONS

Housing	Power supply and sensor support box: 41 cm L x 13 cm W x 7 cm H
Weight without sensors	2.2 kg
Camera module	Stainless steel base with IP65 box 27 cm L x 17 cm W x 9 cm H, weight: 1.5 kg
Power supply	6 V lead acid 12Ah battery with solar panel
Model/Type	Cortex M4 processor module with integrated Communication model for UMTS/LTE operation
Camera and optics	MT9J003 10 Mega Pixel 2/3" CMOS sensors - Optics DSL377A-650-F2.8 2/3" Lens with 2.5 mm Focal length and DSL901J-650-F3.0 2/3" Lens with 12 mm Focal Length

CropVIEW VARIATIONS:

CropVIEW® Panorama

One 10 MP Wide Angle Lens

CropVIEW® Tele

One 10 MP Tele Lens

CropVIEW® Dual

Two 10 MP Lenses - Wide Angle and Tele

CropVIEW® Stereo

Two Lenses - Tele or Panorama



Images, taken by CropVIEW®.

A tool in FieldClimate enables you to select specific fruits on pictures taken in your orchard or field by a zoom lense in CropVIEW®. If you know the precise distance between the camera and crop, you will get a reliable measurement of fruit diameter in mm.



APPLE ORCHARD USE CASE



Tele lens focusing on a tree and detecting the apples automatically (CropVIEW automatic detection).



Marking apples by hand and following their growth during the season.

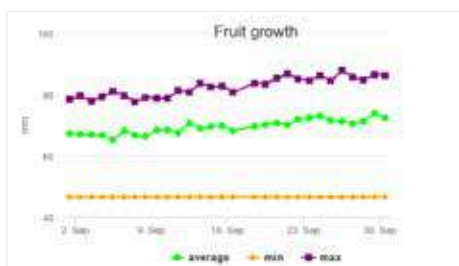

The minimum, maximum and average diameter (in mm) of all selected fruits is shown on a graph, and the exact values in a table (which can be downloaded as an Excel file for further analysis).

VITICULTURE USE CASE



Following the growth of shoots and developing leaves.



Inflorescence of grapes is clearly seen on the photos.

SERIES OF PICTURES IN MAIZE/WHEAT USE CASE



Germination and emergence of wheat.



Different BBCH stages of wheat, for example tillering stages.



Following the uniform emergence and growth of maize daily.

With CropVIEW® you receive a time lapse of your crop growth. Check the time lapse of maize growth here:

https://youtu.be/V_ZXBSD_7XQ



FAMILY NAME: iMETOS Tracker

A battery-powered versatile tracking device that is easily mounted on any asset (sprayer, mower, utility vehicles, tractors, carts, ...).

BEST USED FOR:

- Detailed activity report about where, when, and how much an asset has been operational
- Optimisation and enhancement of work and workforce planning
- Knowing current position of all active machines

APPLICATIONS:

Agriculture (crop growing, animal production), golf courses, parks, smart city

FAMILY MEMBERS: iMETOS Tracker NB-IoT



iMETOS Tracker NB-IoT



iMETOS Tracker is an automatic tracking system used on self propelled vehicles and farm machinery like tractors, combines, trailers and other non-powered machinery.

When the tracker is connected to the external power source, it acts as an Active tracker which reports lots of GPS points while the vehicle is in motion.

When the tracker is not connected to the external power source, it operates on its own internal supercapacitor and solar panel and acts as an object tracker.



iMETOS Tracker used on a golf cart.



TECHNICAL SPECIFICATIONS

Connectivity	NB-IoT or CAT-M1 with 2G fallback (Q2/2020) with internal high gain antenna
GNSS	GPS, GLONASS, GALILEO, BEIDOU, accuracy < 3m, internal high gain GNSS antenna
Housing	UV resistant polycarbonate plastic (Protection class IP67)
Power	(+6...+30) V DC, preinstalled cigarette plug, integrated 25F supercapacitor, solar panel
Communication	It uses UDP protocol for data delivery to FieldClimate platform
Dimensions	72,5 x 73 x 27 mm

ACTIVE TRACKER:

- Records a GPS position and speed every 5 seconds and transfers the data every 30 seconds to FieldClimate.
- It is activated with vibration and movement and records the first position when the super capacitor is sufficiently charged.
- The super capacitor can hold charge when connected to a permanent power source (tractor battery).
- In sleep mode the current uptake is below 100µAmp. It can empty a fully charged 75Ah battery within 750 000 hours. When it is connected to a switched on power source the super capacitor will discharge within 24 hours after being disconnected from power.

OBJECT TRACKER:

- Needs sunlight to operate and to charge the super capacitor.
- Records start position when the object starts to move and the final position where the object stops.
- When the object is in the dark for more than 24 hours the super capacitor gets discharged.

This is what you get with Active tracker:

- A detailed activity report about where, when and how much the machine has been running.
- Current positions of all active machines.
- Enhanced work planning.
- Automatic theft control of assets by geo-fence.

With Object tracker you get the information on when Active and Object trackers are used on the tractor and the trailer connected to the tractor. You can also identify how much the trailer was used in the specific period.

FAMILY NAME: iMETOS MobiLab & Accessories

Indispensable tool for sap and soil-analysis.

BEST USED FOR:

- Precise NO_3 and NH_4 soil analysis
- Precise NO_3 , NH_4 , Na, Cl, SO_4 , K, Ca and Mg analysis from plant sap
- Defining usage of fertilizers and pesticides
- Lowering the impact on the environment (water, biodiversity, soil, ...)

APPLICATIONS:

Agriculture (crop growing), golf course, parks, smart city, research

FAMILY MEMBERS: iMETOS MobiLab variations & Dualex



iMETOS MobiLab – Soil and Plant Sap Analytics



Successful crop growing needs an optimized use of fertilizers. Pessl Instruments has developed a product line to support horticulture and agriculture in this field.

REMOTE PLANT SENSING

The new farm view services integrates Sentinel-2 Earth observations. This helps to determine homogeneous and inhomogeneous zones inside fields. From this data, we can retrieve a useful soil sampling pattern.

SOIL AND PLANT SAP SAMPLING

The iMETOS Soil Sampler app records the soil sample position and sampling time. It assigns a unique identifier (UI) to each soil and plant sap sample. With the data retrieved from satellite images, recommendations for sampling localization on the field can be provided. After saving the UI, sampling time and position are stored in FieldClimate and workflow is suggested. Data can be synced with the iMETOS MobiLab Software (Windows 7 or newer).



With a simple garlic press and some plastic gear one can easily take samples from leaves. A cell phone app guides you through the selection of leaves and the entire procedure, to ensure optimum results. By using satellite images, the software can also recommend sampling sites to make the obtained data representative for the whole field.



This project has received funding from the European Union's Horizon 2020 research and innovation programme under the grant agreement No. 765262.

SOIL EXTRACTION

The **iMETOS MobiLab Soil Extraction** set contains the hardware to take a soil sample and prepare an extract for further measurement. The set contains a sieve and a bowl for purifying and homogenizing the solid soil sample. A tube takes the sample up and fits into a tailor-made balance. Distilled water is then added. The balance records the actual share of the sample and the water, therefore error tolerant working is possible. Afterwards, the tube is placed on a shaker and left there for 30 minutes in order to extract the nitrogen compounds. Balance and shaker communicate with the MobiLab software. The generated data is then sent to FieldClimate.

iMETOS MobiLab SOIL EXTRACTION®

Power supply	12 V adaptor for wall outlet or plug for car outlet
Battery	2 h working time



SINGLE NUTRIENT MEASUREMENT

The **iMETOS MobiLab LAQUAtwin® NO₃** is an ion selective electrode (ISE) capable of measuring nitrate. After a one point calibration, to be done just once a day, the LAQUAtwin receives some droplets of the soil extract on the ISE and returns the concentration of nitrate immediately. This value can be entered into the MobiLab Software and then stored in FieldClimate.

The **iMETOS MobiLab LAQUAtwin® NH₄** works exactly the same. However, the ISE is made for ammonia.

iMETOS MobiLab LAQUAtwin®

Minimum sample volume	more than 300 µl
Measurement range	6 - 9900 ppm; 1,4 to 2200 mg/l
Resolution	1 ppm for less than 100 ppm, 10 ppm for less than 1000 ppm and 100 ppm for less than 10 000 ppm
Battery life	400 h
Waterproof	IP67

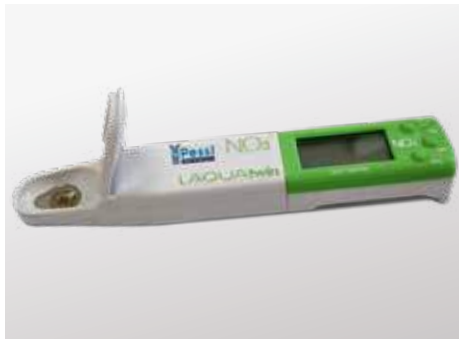
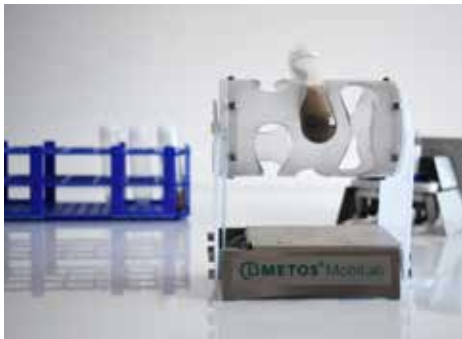

MULTI NUTRIENT MEASUREMENT:

The **iMETOS MobiLab LabOnAChip®** measures soil samples via capillary electrophoresis (CE). The LabOnAChip device operates the chip in an automated manner and communicates with the MobiLab software. An internal standard (ISTD) needs to be added to the filtered soil extract before measuring. This mixture is then transferred into the sample hole of the device with a pipette. After clicking on "start" in the MobiLab Software the measurement is conducted automatically. Results are returned and saved within 3 minutes and the data is also sent to FieldClimate. The nutrients measured are nitrate and ammonia for soil. For other sources like plant sap, waste water or manure etc., additional nutrients measurements are possible.

iMETOS MobiLab LabOnAChip®

Sample volume	50-100 µl
Measurement range	3-1000 ppm; 0.01-0.5 g/kg
Resolution	0.5 ppm; 1 mg/kg
Accuracy	For measurements of liquid concentrations (ppm): ±3 % For measurements of soil concentrations (mg/kg): ±15 %
Chip lifetime	Approximately 300-500 tests
Battery life	2 hours of measuring time



Dualex - Instant non-destructive Nitrate and Chlorophyll Measurement

Dualex is a leafclip sensor which measures chlorophyll and polyphenols content of plant leaves.

Thanks to a patented technology, this optical sensor allows simple, fast and non-destructive measurement of chlorophyll, flavonols and anthocyanins in leaves.



ACCURATE MEASUREMENT OF CHLOROPHYLL

Chlorophyll plays a vital role in photosynthesis and plant development. Dualex measures the chlorophyll by analyzing the light transmitted through the leaf. Thanks to a chemical calibration made by FORCE-A, the chlorophyll is given in $\mu\text{g}/\text{cm}^2$ in the range of 5-80 $\mu\text{g}/\text{cm}^2$.

UNIQUE LEAFCLIP SENSOR TO MEASURE FLAVONOLS AND ANTHOCYANINS CONTENT IN LEAVES

Flavonols are mainly synthesized after light exposure. As a consequence, they are a good indicator of plant-light interaction history.

Dualex measures flavonols and anthocyanins by analyzing the screening effect of flavonols and anthocyanins on chlorophyll fluorescence. Flavonols and anthocyanins content are given in relative absorbance units from 0 to 3 for flavonols and 0 to 1.5 for anthocyanins.

NBI®: NITROGEN BALANCED INDEX

Chlorophyll is often used as an indicator of plant nitrogen status. Several years of research and experimentation showed that polyphenols, specifically flavonols, are also good indicators of nitrogen status of plants.

NBI® (Nitrogen Balance Index) combines chlorophyll and flavonols (related to nitrogen/Carbon allocation). It's a nitrogen plant status indicator directly correlated with massic nitrogen content. The NBI® is less sensitive to the variations of environmental conditions than the chlorophyll (leaf age, leaf thickness...).

TECHNICAL SPECIFICATIONS

Measuring material	Plant leaves
Measuring system	Transmittance and screening effect on chlorophyll fluorescence
Index measured	Chlorophyll (CHL), Flavonols (FLAV), anthocyanins (ANTH), NBI
Accuracy	5%
Reproducibility	4,5% for CHL, 3,5% for FLAV and ANTH
Repeatability	1,3% for CHL, 2% for FLAV and ANTH
Area measured	19,6 mm ²
Leaf thickness	1.5 mm maximum
Measurement time	< 1 s
User interface	LCD screen, Sound warning
Positioning	Internal GPS
Relative accuracy	< 2,5 m (CEP, 50%, 24 h static)
Storage capacity	10 000 multiparametric data
Data output	.csv file
Data transfer	USB
Operating temperature	From 5 to 45 °C
Battery	Li-ion rechargeable
Autonomy	6 hours
Total weight	220 g
Size	205 x 65 x55 mm

FAMILY NAME: iMETOS SoilGuard

A perfect portable tool for measuring soil moisture and temperature.

BEST USED FOR:

- Work planning & water management
- Complete field's moisture profile
- Complete field's heat map based on temperature readings
- Accurate measurements

APPLICATIONS:

Agriculture (crop growing), golf courses, parks, smart city

FAMILY MEMBERS: iMETOS SoilGuard

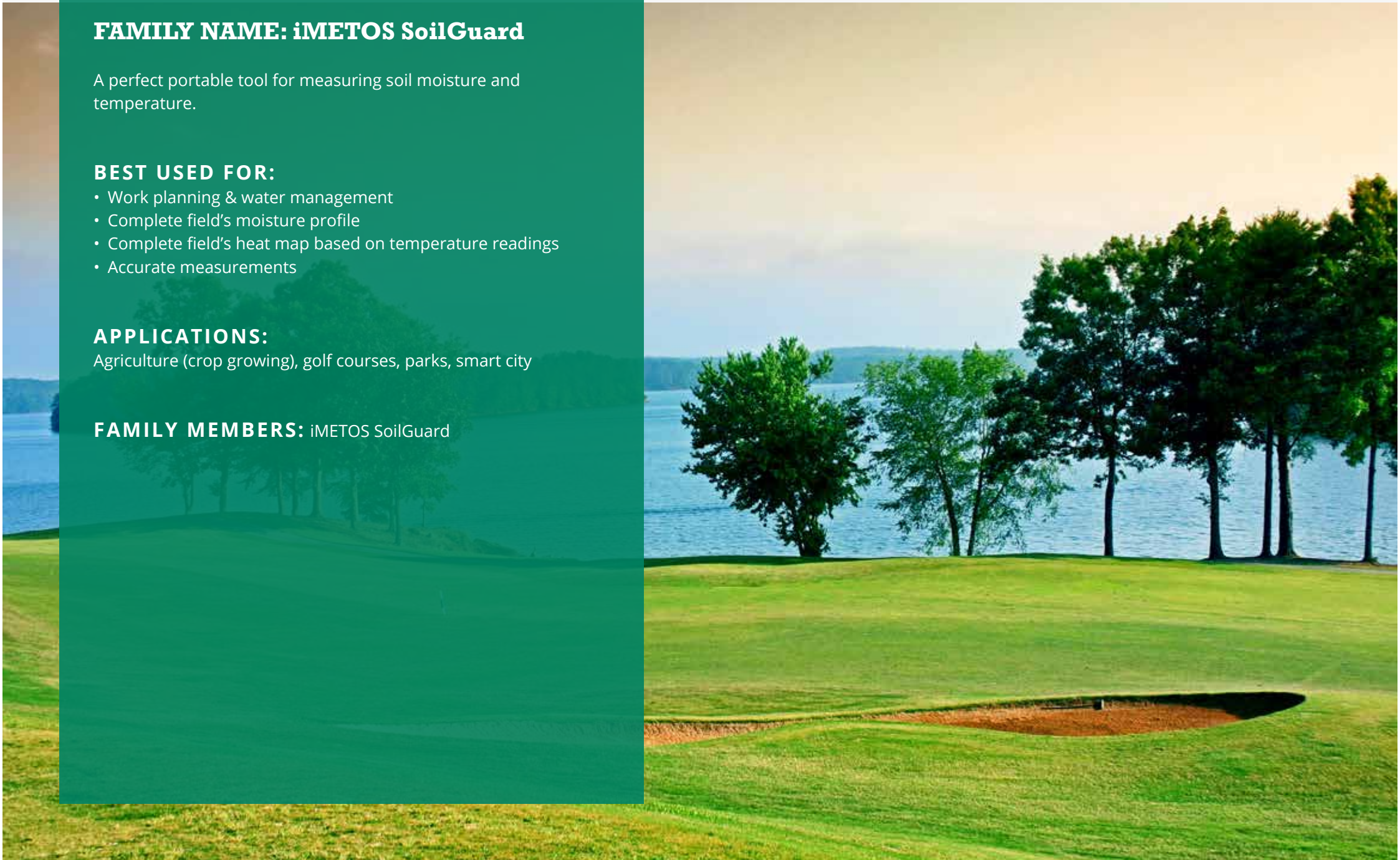

iMETOS SoilGuard



The new iMETOS SoilGuard solution is the perfect mobile tool for measuring soil moisture and temperature in turf grass, wherever you want/need and combine it with permanent readings and your own good feelings. Due to its portability and simplicity of use it enhances the efficiency, and helps to optimise work planning and water management. Once in place, it measures soil moisture right in the root zone. The readings are stored on the device and whenever needed - GuardMap the mobile app sends point data to Fieldclimate and within a few seconds data is visible for any other stakeholder. Together with the permanent readings and the mobile application and the spot readings from iMETOS SoilGuard you will get a complete picture of the golf course's moisture profile, the temperature readings on the various points of the green in a form of a heat map for easier understanding and further decision-making.



KEY FEATURES:

- easy to use, mobile and rapid measurements
- easy-readable backlit display to see the values immediately
- provides up to 50,000 measurements, all with their specific GPS coordinates
- has an ergonomic design with a telescoping tubular frame
- comes with integrated Bluetooth and internal GPS therefore no additional connectivity components are necessary
- **it provides accurate measurements of:**
 - soil moisture (Volumetric Water Content %)
 - electrical conductivity (salts)
 - turf grass surface temperature



Using iMETOS SoilGuard

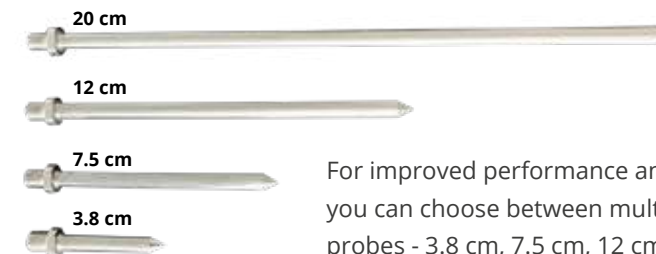

For improved performance and accurate measurements, you can choose between multiple lengths of measuring probes - 3.8 cm, 7.5 cm, 12 cm and 20 cm.

Sensors



Pessl Instruments Ultrasonic Wind Sensor

Order number: PI-USWM

Pessl Instruments ultrasonic wind speed sensor is a two-dimensional sonic wind sensor, built specifically for agricultural, forestry, and environmental research applications. It calculates average and maximum (gust) wind speed and direction over 5 minutes interval.



CONNECTION TO MOTHERBOARDS

iMETOS 3.3

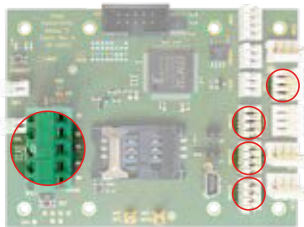

iMETOS ECO D3



μMETOS NB-IoT/CLIMA

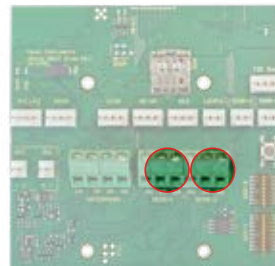

TECHNICAL SPECIFICATIONS

Output data format	PI-bus
Information transmitted	Average wind speed, gust and direction
Output rate	1-10 min
Wind module sensitivity	0.12 m/s
Wind module resolution	0.05 m/s
Wind module dynamic	0.12 to 40 m/s
Direction sensitivity	+/-1.5°
Direction resolution	1°
Power supply	5.5 V to 6V
Electrical consumption	0.5 mA Avg. 12 V
Operating temperature without icing	-15° C to +55° C
Cable	2.5 m / LIYCY
Connection	4 wires
Weight of the head	N/A
Weight of unit assembly	200 g with mounting part
Mounting	Pessl Instruments clamp

Pessl Instruments Wind Speed

Order number: IM512CD

IM512CD is a cup type anemometer for low cost and long term, accurate wind measurements for all kinds of use. It calculates average wind speed in the specific time period.



TECHNICAL SPECIFICATIONS

Range	0 to 50 m/s, gust survival 60 m/s
Sensor	12 cm diameter cup wheel assembly, 40 mm diameter hemispherical cups
Turning factor	75 cm
Distance constant (63 % recovery)	2.3 m
Threshold	1.1 m/s
Transducer	Stationary Coil
Transducer output	AC sine wave signal induced by rotating magnet on cup wheel shaft. 100 mVpp at 60 rpm. 6 Vpp at 3600 rpm
Output frequency	1 cycle per cup wheel revolution. 0.75 m/s per Hz

CONNECTION TO MOTHERBOARDS

iMETOS 3.3

µMETOS NB-IoT/CLIMA

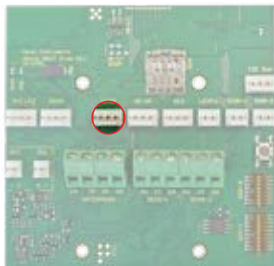
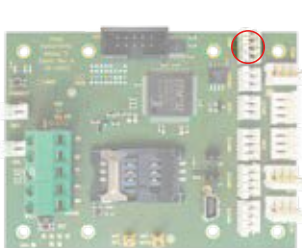

Pessl Instruments Wind Direction

Order number: IM511CDI

IM511CDI is a vane type digital wind direction sensor for accurate measurements in all weather conditions. It calculates average wind direction in the specific time period.



TECHNICAL SPECIFICATIONS

Range	360° mechanical, 352° electrical (8° open)
Sensor	Balanced vane, 16 cm turning radius
Damping ratio	0.2
Delay distance	0.5 m
Threshold	1.3 m/s at 10° displacement; 1.9 m/s at 5° displacement
Transducer	Precision conductive plastic potentiometer, 10 kOhm ±20 % resistance 1.0 % linearity, life expectancy 50 million revolutions Rated 1 watt at 40 °C, 0 watt at 125 °C
Transducer excitation requirement	Embedded micro controller
Output	RS 485

CONNECTION TO MOTHERBOARDS

iMETOS 3.3

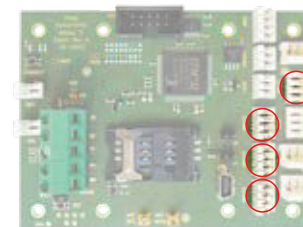

RM Young Wind Monitor

Order number: 05103L

The wind monitor combines wind speed and wind direction. It is constructed of a four-blade helicoid propeller for highly accurate wind speed measurement with integrated wind direction sensor. It measures peak values.



CONNECTION TO MOTHERBOARDS

iMETOS 3.3

iMETOS ECO D3

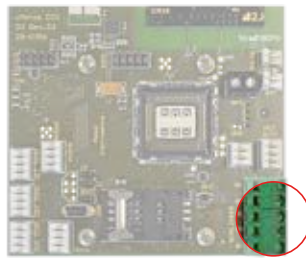
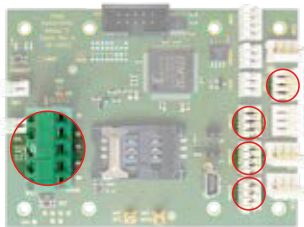

TECHNICAL SPECIFICATIONS

Range	0-100 m/s (224 mph), 0- 360°
Accuracy	Wind Speed: ± 0.3 m/s (0.6 mph) or 1% of reading Wind Direction: $\pm 3^\circ$
Operating temperature range	-50 to 50 °C
Threshold	Propeller: 1.0 m/s (2.2 mph) Vane: 1.1 m/s (2.4 mph)
Signal output	Wind speed: magnetically induced AC voltage, 3 pulses per revolution. 1800 rpm (90 Hz) = 8.8 m/s (19.7 mph) Wind direction: DC voltage from conductive plastic potentiometer – resistance 10K Ω , linearity 0.25%, life expectancy – 50 million revolutions
Power Requirement	Potentiometer excitation: 15 VDC maximum
Dimensions	37 cm (14.6 in) H x 55 cm (21.7 in) L, Propeller: 18 cm (7 in) dia. Mounting: 34 mm (1.34 in) dia. (standard 1 inch pipe)
Weight	1.0 kg

Hygroclip (Air temperature & Relative Humidity)

Order number: A660611

Measures relative humidity and temperature with outstanding accuracy and repeatability. It has an integrated data acquisition and calibration history. Dew point, VPD and delta T calculations available.



CONNECTION TO MOTHERBOARDS

iMETOS 3.3

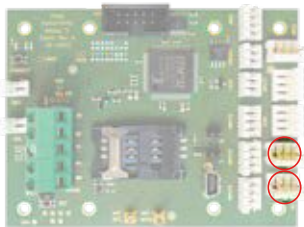

iMETOS ECO D3

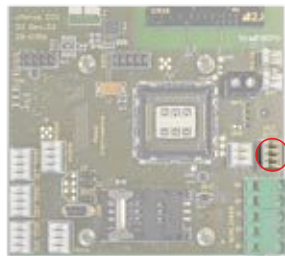

µMETOS NB-IoT/CLIMA

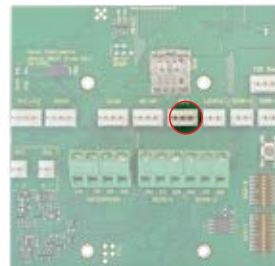

TECHNICAL SPECIFICATIONS

Temperature sensor	PT1000 1/3 Class B
Humidity sensor	ROTRONIC Hygromer® IN-1
Accuracy with standard adjustment profile	at 23 °C and 10, 35, 80 % rh ±0.8 % rh / ±0.1 °C
Accuracy with high precision adjustment profile	at 23 °C and 10, 20, 30, 40, 50, 60, 70, 80, 90 % rh ±0.5 % rh / 0.1 °C
Resolution, AirChip3000	Typically 0.02 % rh, 0.01 °C
Long-term stability	< 1 % rh, 0.1 °C / year
Humidity response time t₆₃	3 seconds
Measurement range	0...100 % rh, -100...200 °C
Electronics operating range	-50-100 °C and 0-100 % rh
Output signals	Serial port RS485
Audit trail & electronic records	FDA 21CFR Part 11 and GAMP compliant
Power supply & consumption	3.2 V / 4 mA
Housing/probe material	Polycarbonate
Filter	Polyethylene insert, polycarbonate cage
Standards	CE-compliant 2007/108/EG

Pessl Instrument Air Temperature & Relative Humidity Sensor

Order number: IM526TR-SHLD

Measures air temperature and relative humidity and is used for low power consuming applications on μ METOS CLIMA (LoRaWAN™, NB-IoT) and iMETOS ECO D3.

I2C Bus Considerations: I2C Bus is sensitive to the electromagnetic waves and can be distorted under certain conditions. On the contrary, Hygroclip is less sensitive. Recommended cable length: not longer than 1 m.



CONNECTION TO MOTHERBOARDS

iMETOS ECO D3

μ METOS NB-IoT/CLIMA

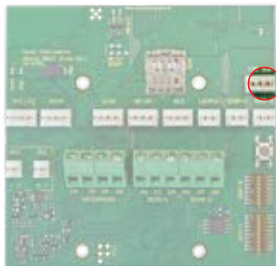
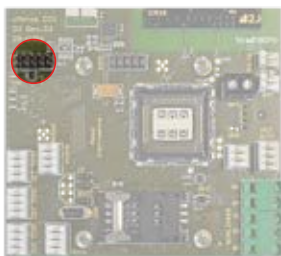

TECHNICAL SPECIFICATIONS

Sensor	HYT221
Operating temperature range	-40°C to +125°C
Humidity range	0% to 100% RH
Accuracy	±0.2°C (0°C to +60°C) ±2 % RH at +23 °C (0% to 90% RH)
Operating voltage	2.7V to 5.5V
Digital interface	I ² C, address 0x28 or alternative address
Operating voltage (limit data)	0.3 V to +6 V
Storage conditions	-20 °C to +50 °C

Pessl Instruments Wet and Dry Bulb Temperature

Order number: *IM505CD*

Two highly reliable and tested PT1000 are built in a waterproof housing. One of them is covered with cotton tissue and wetted with water.



CONNECTION TO MOTHERBOARDS

Order number: *IM505CD*

iMETOS 3.3

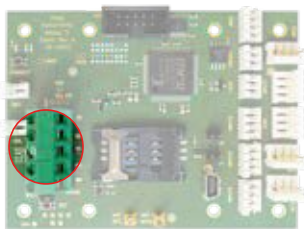

iMETOS ECO D3

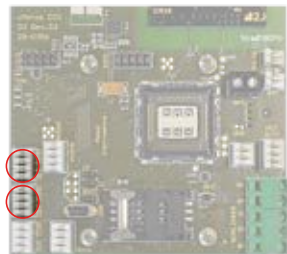

µMETOS NB-IoT/CLIMA

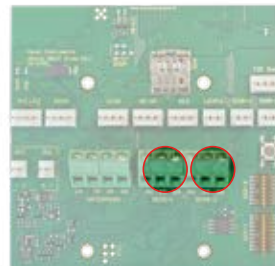

TECHNICAL SPECIFICATIONS

Sensor	PT1000 (technical details of PT1000 are under hygroclicp)
Supply voltage	4.57-7 V for chain version
Supply current	max. 200 µA
Short circuit protection	Infinite (within supply voltage range)
Short circuit supply current	max. 40 mA
Operating temperature range	-30 °C to +60 °C
Accuracy	0.1 °C
Cable length	5 m

VARIATIONS

- Wet&Dry bulb temperature sensor PI-bus solution on all devices (*order number: IM505CD*)
- Wet&Dry bulb temperature for iMETOS ECO D3 (*order number: IM505ECO*)
- for IMT series: wet bulb temperature without holder (*order number: IM504IMT*)
- for iMETOS ECO D3: wet bulb temp without holder (*order number: IM504ECO*)
- Dry temperature on iMETOS ECO D3 (*order number: IM506ECO*)
- Dry temperature on IMT series (*order number: IM506IMT*)

Order number: *IM504IMT / IM506IMT*

iMETOS 3.3

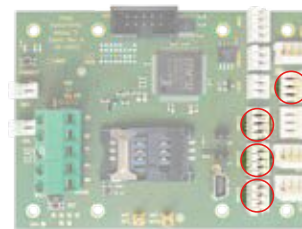

Order number: *IM505ECO / IM506ECO*

iMETOS ECO D3

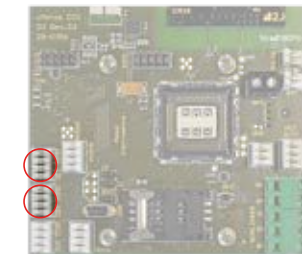

Pessl Instruments Soil Temperature

Order number: IM5041D

The Soil Temperature Sensor is a PT1000 in a waterproof stainless steel housing. The sensor output is a duty-cycle signal.



TECHNICAL SPECIFICATIONS

Sensor SMT172	Operating temperature range: -30 °C to +75 °C Accuracy: ± 0.5 °C (-30 °C to +75 °C)
Sensor PT1000	Operating temperature range: -30 °C to +75 °C Accuracy: ± 0.1 °C (-30 °C to +75 °C)
Supply voltage	4.57-7 V
Supply current	max. 200 μ A
Short circuit protection	infinite (within supply voltage range)
Short circuit supply current	max. 40 mA
Calibration error	max. 0.25 °C (23 °C)
Nonlinearity error	max. 0.2 °C
Supply voltage sensitivity	max. 0.1 °C/V
Repeatability	max. 0.2 °C
Long term drift	max. 0.1 °C
Output frequency	1 to 4 kHz
Evaluation	Duty cycle
Cable length	5 m

CONNECTION TO MOTHERBOARDS

iMETOS 3.3

iMETOS ECO D3

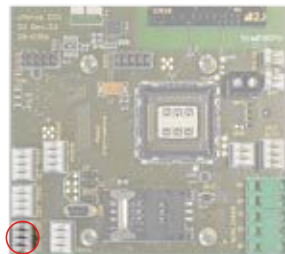
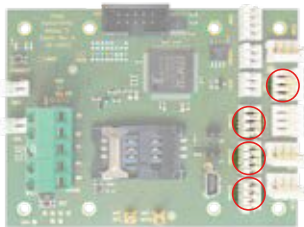

Pessl Instruments Multiple Soil Temperature

Order number: SAR19/SAR19M

SAR19/SAR19M provides soil temperature measurement from several centimeters to 15-meter deep by using the Pessl Instruments sensor BUS. The distance between the sensors can be chosen according to the application, but only up to 10 sensors can be attached to one sensor chain.



TECHNICAL SPECIFICATIONS

Temperature sensor	DS18B20
Operating temperature range	-55 °C to +125 °C
Supply DC voltage (range)	3-5.5 V
Thermometer error -10 °C to +85 °C	±0.3 °C
Drift	±0.2 °C
Data transmission	Rs 485 Digital signal (temperature data sent on demand of iMETOS main board)

CONNECTION TO MOTHERBOARDS

iMETOS 3.3

iMETOS ECO D3

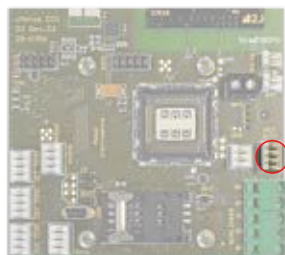
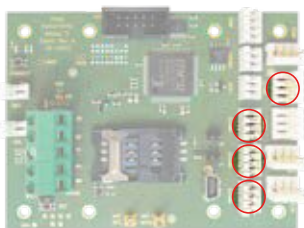

Pessl Instruments Single Soil Temperature

Order number: WMTEMP

WMTEMP is a soil temperature sensor usually used with Watermark sensors on iMETOS ECO D3.



TECHNICAL SPECIFICATIONS

Temperature sensor	DS18B20
Operating temperature range	-55 °C to +125 °C
Supply DC voltage (range)	3-5.5 V
Thermometer error -10 °C to +85 °C	±0.3 °C
Drift	±0.2 °C
Data transmission	Rs 485 Digital signal (temperature data sent on demand of iMETOS main board)

CONNECTION TO MOTHERBOARDS

iMETOS 3.3

iMETOS ECO D3

μMETOS NB-IoT/CLIMA/SOIL

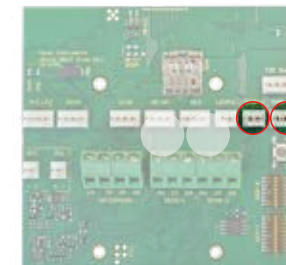
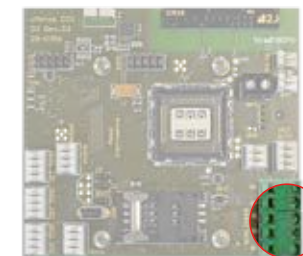
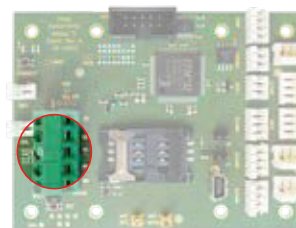

INTERFACE

Necessary Interface to connect this sensor with iMETOS:

ECH871EXT, ECH874EXT or ECH871INT, ECH874INT or RFRN09, RFRN12 or WM-BUS

Pessl Instruments Heavy Duty Multiple-temperature Probe

Order number: MUSO

Multiple-temperature probe is a thermometer, designed to make measurements in extremely harsh conditions like temperature of waste on disposal sites, and chipped wood in storage rooms.



TECHNICAL SPECIFICATIONS

Operating temperature range	-55 °C to +125 °C
Supply DC Voltage (range)	3-5.5 V
Thermometer error -10 °C to +85 °C	±0.3 °C
Drift	±0.2 °C
Data transmission	Rs 485 Digital signal (temperature data sent on demand of iMETOS main board) iMETOS checks all sensors every 5 minutes

CONNECTION TO MOTHERBOARDS

iMETOS 3.3

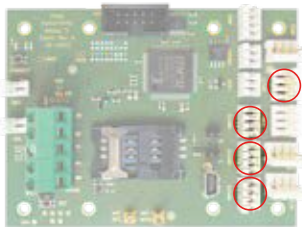

iMETOS ECO D3

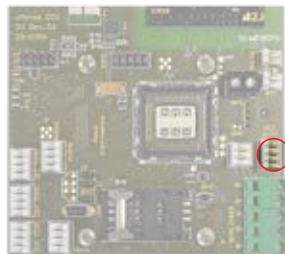

µMETOS NB-IoT/CLIMA

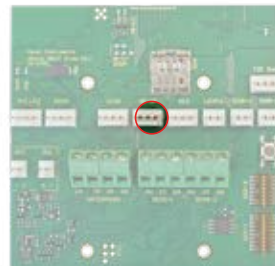

Pessl Instruments Leaf Temperature

Order number: IM522CD

IM522CD is a highly accurate leaf temperature sensor. It measures the radiated temperature around the surface of a leaf or a canopy.



TECHNICAL SPECIFICATIONS

Sensor	PT1000
Accuracy	min. 0.1 °C (-30 °C to +99 °C)
Supply current	max. 200 µA
Short circuit protection	Infinite (within supply voltage range)
Short circuit supply current	max. 40 mA
Operating temperature range	-30 °C to +99 °C
Nonlinearity error	max. 0.2 °C
Supply voltage sensitivity	max. 0.1 °C/V
Repeatability	max. 0.2 °C
Long term drift	max. 0.1 °C
Output frequency	1 to 4 kHz
Duty cycle	0.320 (0 °C), 0.00470 °C
Evaluation	Analog
Cable length	5 m

CONNECTION TO MOTHERBOARDS

iMETOS 3.3

iMETOS ECO D3

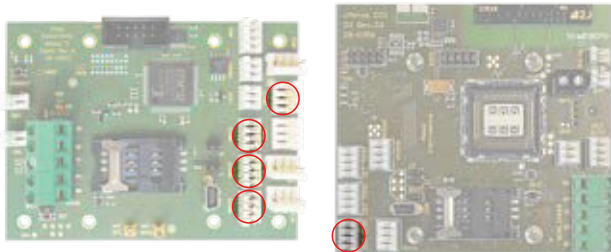

Pessl Instruments IR Temperature

Order number: IRTEMP

The infrared temperature sensor infers the temperature from a portion of thermal radiation (blackbody radiation) emitted by the object being measured. It is a non-contact temperature sensor. By measuring the amount of infrared energy emitted by the object and its emissivity, the object's temperature can be determined. Main use: canopy or leaf temperature measurements.



TECHNICAL SPECIFICATIONS

Sensor	Melexis MLX90614-BCC
Resolution	0.1 °C
Interface	RS 485 PI Sensor Bus
Size	20 mm (dia) x 24 mm
Sensor housing	Weather resistant PAS
Range	-40 °C to +85 °C

CONNECTION TO MOTHERBOARDS

iMETOS 3.3

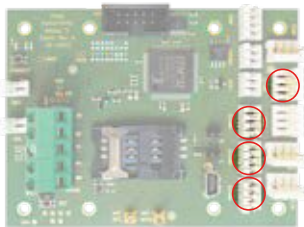

iMETOS ECO D3



Pessl Instruments Leaf Wetness

Order number: IM521CD

The leaf wetness sensor works by measuring the conductivity on a filter paper, which is held between two stainless steel electrodes in a transparent holder. The use of transparent Lucite plastic as a holder reduces the warming up of the sensor when it is exposed to direct sunlight.



TECHNICAL SPECIFICATIONS

Supply voltage	4.75-5.25 V
Supply current	max. 1500 μ A
Short circuit protection	Infinite (within supply voltage range)
Dry / Wet threshold	220-390 kOhm
Output	Dry: max. 0.4 VDC Wet: min. VCC-0.4 VDC
Electronic	Totally plastic encapsulated – SMD
Dimensions	42 mm x 78 mm x 15 mm
Cable length	5 m

CONNECTION TO MOTHERBOARDS

iMETOS 3.3

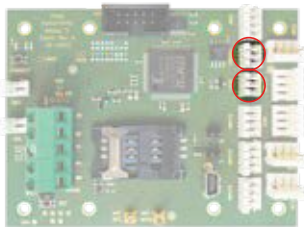

iMETOS ECO D3

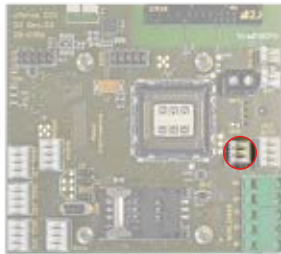

μ METOS NB-IoT/CLIMA

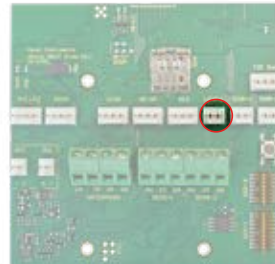

Pessl Instruments Rain Gauge

Order number: IM523

The mechanic consists of a magnet, which moves past a reed switch and opens or closes the circuit. The double spoon tips left or right and does not lose any water due to a very fast switching mechanics. The resolution with a surface of 200 cm² is 0.2 mm, while the resolution with the 80 cm² is 0.5 mm. Heating for rain gauge can also be included.



CONNECTION TO MOTHERBOARDS

iMETOS 3.3

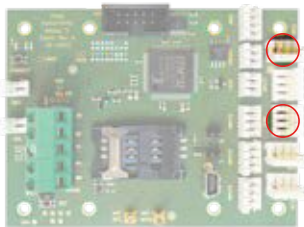

iMETOS ECO D3

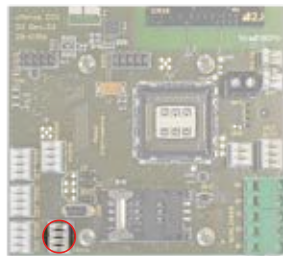

μMETOS NB-IoT/CLIMA/SOIL

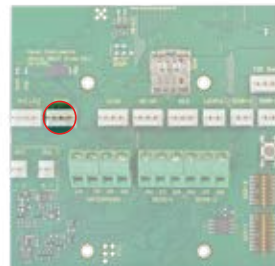

TECHNICAL SPECIFICATIONS

Sensor type	Double tipping bucket rain gauge
Output	Switch signal
Switch	Reed contact, solid state
Sensitivity	1 tip per 0.2 mm or 1 tip per 0.5 mm
Collector surface	200 cm ²
Evaluation	Digital
Maximum rain	12 mm/minute
Dimensions	185 mm diameter x 250 mm H
Accuracy	±5 %

Protect your rain gauge from birds - add bird protection crown. Very easy to install and dismantle.

Order number: IM523-CWN



Pessl Instruments High Precision Rain Gauge

Order number: HPR1000

The sensor is a well-designed tipping bucket rain gauge which combines a high resolution and high precision at a very small construction volume. The rain[e]one is ideal to setup new measurement network as well as addition to an existing rainfall measurement network. The proven mechanic of a Pessl Instruments High precision rain gauge consists of a magnet, which moves past a reed switch and opens or closes the circuit. The double spoon tips left or right and does not lose any water due to a very fast switching mechanics to precisely measure high intense rainfall events. The resolution with a surface of 200 cm² is 0.1 mm. Heating for rain gauge can also be included.



CONNECTION TO MOTHERBOARDS

iMETOS 3.3

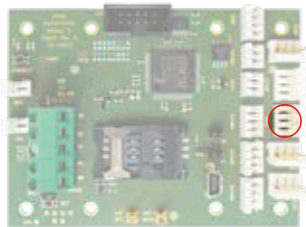

iMETOS ECO D3

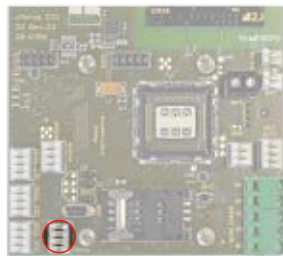

μMETOS NB-IoT/CLIMA/SOIL

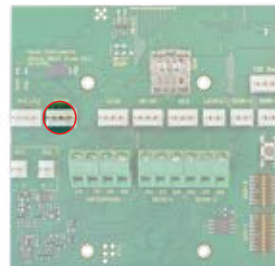

TECHNICAL SPECIFICATIONS

Resolution	minimum 0.1 mm
Accuracy	±1 % at 1 mm/min
Amount resolution	without limitation
Intensity range	0-10 mm/min resp. 0-600 mm/h
Intensity resolution	0.1 mm/min resp. 0.001 mm/h
Collecting surface area	minimum 200 cm ²
Measuring principle	tipping bucket
Working range	0-65 °C
Housing material	glass-epoxy laminate
Holder	stainless steel bracket holder
Protection class	IP67
Standards	WMO-No. 8 • VDI 3786 Bl. 7 • EN 61000-2, -4 • EN 61000-4-2, -3, -4, -5, -6, -11 • NAMUR NE-21

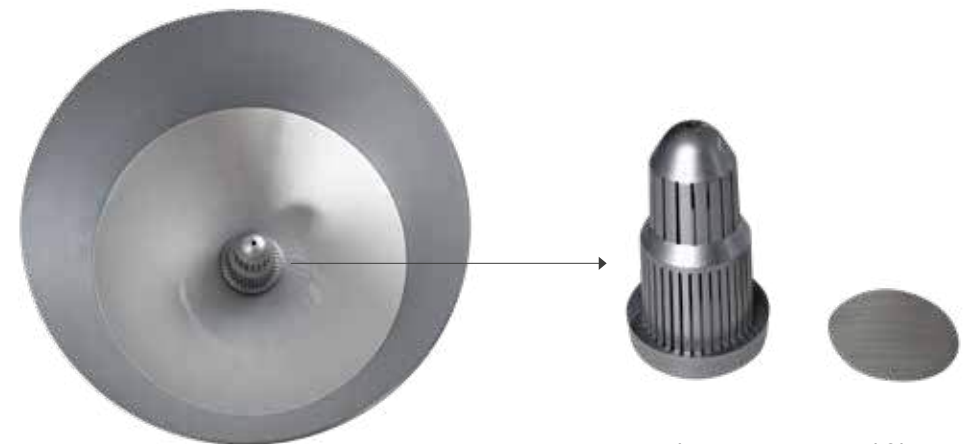

Debris protection and filter

Pessl Instruments Soil Moisture & Soil Temperature Sensor PI54-D

Order number: PI54-D/5

The PI54-D soil moisture sensor and soil temperature sensor has a larger volume of influence. It determines volumetric water content (VWC) by measuring the dielectric constant of the soil using capacitance technology and soil temperature. It is 10 cm long and thus measures 1 Liter of soil, while high frequency minimizes salinity and textural effects which makes PI54-D accurate in most soils.



CONNECTION TO MOTHERBOARDS

iMETOS 3.3

iMETOS ECO D3

µMETOS NB-IoT/CLIMA/SOIL

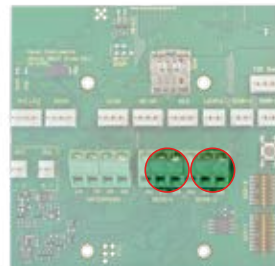
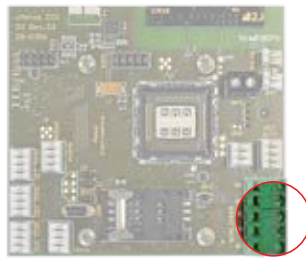
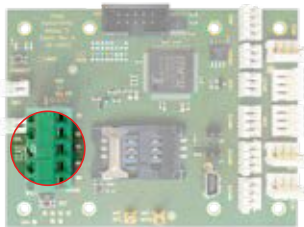

TECHNICAL SPECIFICATIONS

	Range: 0–0.57 m ³ /m ³ (0%–57% VWC)
	Resolution: 0.0008 m ³ /m ³ (0.08% VWC) in mineral soils from 0–0.50 m ³ /m ³ (0%–50% VWC)
Volumetric water content (VWC)	Accuracy: With standard calibration equation, 0.03 m ³ /m ³ (3% VWC) typical in mineral soils that have solution electrical conductivity <10 dS/m NOTE: With soil-specific calibration, ±0.02 m ³ /m ³ (±2% VWC) is typical in any soil.
Dimensions	16.0 cm (6.3 in) length; 3.3 cm (1.3 in) width; 0.8 cm (0.3 in) height
Prong length	10 cm (3.94 in)
Operating temperature range	-40 to 50 °C
Cable length	5 m
Supply voltage (VIN to GND)	Minimum: 3.6 VDC at 12 mA Maximum: 15 VDC at 20 mA
Measurement duration	Maximum 10 ms
Temperature accuracy - PI54-D	±0.3
Output	Digital

INTERFACE

Necessary Interface to connect this sensor with iMETOS:
ECH870EXT, ECH871EXT, ECH874EXT or ECH870INT, ECH871INT, ECH874INT or RFRN09,
RFRN12, RFRN13

Sentek Drill & Drop and TriSCAN Probe

Order number: SE100 / SE300 / SE600/ SE900 / SE1200 / SE100S / SE300S / SE600S / SE900S / SE1200S

Sentek Drill & Drop probe provides the user with great flexibility for precision monitoring of temperature, water and salinity (Triscan) at multiple depths in a soil profile. Available in five lengths: 10 cm, 30 cm, 60 cm, 90 cm and 120 cm with sensors fixed at every 10 cm increment.

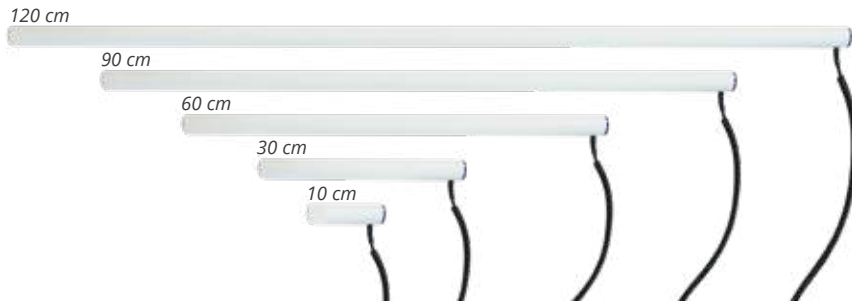

CONNECTION TO MOTHERBOARDS

iMETOS 3.3

iMETOS ECO D3

µMETOS NB-IoT/SOIL

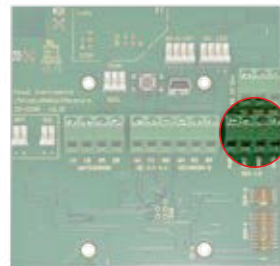
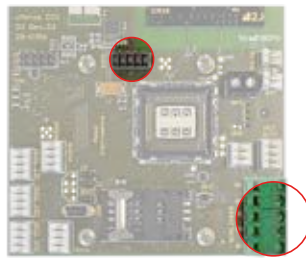
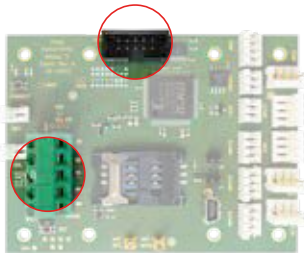

TECHNICAL SPECIFICATIONS

Probe lengths	10 cm (4") / 30 cm (12") / 60 cm (24") / 90 cm (36") / 120 cm (48")
Number of sensors	1 / 3 / 6 / 9 / 12
Outer probe diameter (top-bottom)	24-24.5 mm / 28-29.5 mm / 27-29.5 mm / 26-30 mm / 24.5-29.5 mm
Moisture (VWC) range	Oven dry to saturation
Method	Capacitance based technology
Resolution	Moisture (VWC): 1:10000 Salinity (Triscan) (VIC, Volumetric Ion Content): 1:6000 Temperature: 0.3 °C
Moisture precision	±0.03 % vol.
Temperature accuracy	±2 °C at 25 °C
Operating temperature range	-20 °C to 60 °C

INTERFACE

Necessary Interface to connect this sensor with iMETOS:
SDI12_Chain, SDI12_X2, SDI12_WX2, RFRN13

Irrrometer Watermark Soil Moisture Sensor

Order number: MD510SM

The Watermark Sensor consists of two concentric electrodes buried in a special reference matrix material that is held in place by a synthetic membrane. The matrix material has been selected to reflect the maximum change of electrical resistance over the growth range of crop production, as well as to neutralize the effect of soil salinity. In operation, soil moisture is constantly being absorbed or released and the electrical resistance between the electrodes changes. This resistance is read and logged by the weather station.

The sensor is manufactured from non-corrosive materials and lasts up to three years.



CONNECTION TO MOTHERBOARDS

iMETOS 3.3

iMETOS ECO D3

µMETOS NB-IoT/SOIL

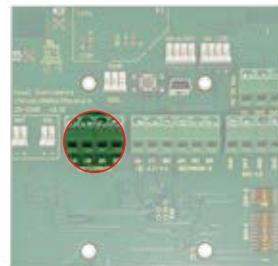
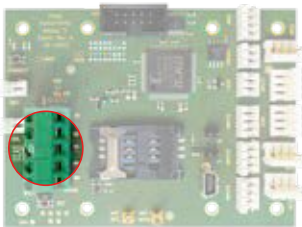

TECHNICAL SPECIFICATIONS

Size	2.2 cm diameter x 5 cm length
Measuring principle	Soil water tension correlated with electrical resistance in granular matrix
Working range	0 to 200 kPa
Precision	5 %
Evaluation	Analog
Cable length	5 meters

INTERFACE

Necessary Interface to connect this sensor with iMETOS:
WM-BUS, ECH871EXT, ECH874EXT or WM-BUSINT, ECH871INT, ECH874INT or RFRN09,
RFRN12, RFRN13

Irrrometer Tensiometer

Order number: TNS101

The instrument measures soil water tension (or suction). This value represents the energy a plant's root system uses to draw water from the soil. Understanding soil moisture dynamics helps the user make informed irrigation scheduling decisions, resulting in improved yield quantity and quality while reducing water, fertilizer, labor and energy costs. Available in different lengths: 15 cm, 30 cm, 45 cm, 60 cm and 90 cm.



CONNECTION TO MOTHERBOARDS

iMETOS 3.3

iMETOS ECO D3

µMETOS NB-IoT/SOIL

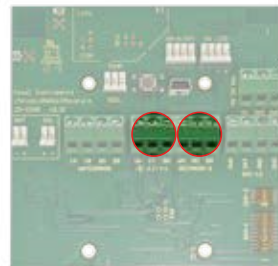
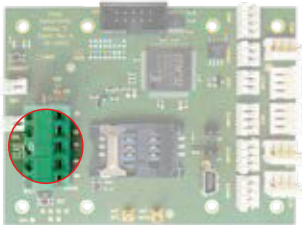

TECHNICAL SPECIFICATIONS

Instrument body materials	Butyrate body, ceramic tip, neoprene stopper
Weight	30 cm weights 0.439 kg. It increases 0.114 kg per 30 cm
Ceramic tip	White tip – used for most soil types
Operating suction	0-90 kPa
Operating temperature range	0 °C to 50 °C
Reservoir dimensions	Height: 120-130 mm including cap; Diameter: 51-55 mm including cap
Body tube dimensions	Length: ranges from 15 to 90 cm; Diameter: 22 mm

INTERFACE

Necessary Interface to connect this sensor with iMETOS:
ECH870EXT, ECH871EXT, ECH874EXT or ECH870INT, ECH871INT, ECH874INT or RFRN09,
RFRN12, RFRN13

EC & pH Interface Box with Display in IP65 Box

Order number: EC500PH

The EC500PH EC & pH Interface box is a measuring device with display in IP65 Box to be integrated into any iMETOS sensor chain interface for continuous EC & pH measurements in water. It is compatible with the majority of industry standard EC & pH sensors. The actual reading can be seen on the display. With the built in calibration mode, all sensor readings can be calibrated and checked from time to time.



Connection Possibilities

- 1 EC Sensor (Part.no. EC501)
- 1 pH Sensor (Part.no. PH501)

CONNECTION TO MOTHERBOARDS

iMETOS 3.3

iMETOS ECO D3

µMETOS NB-IoT/CLIMA

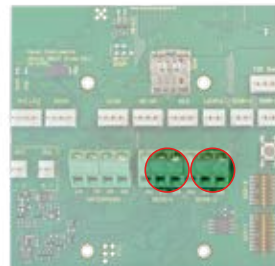
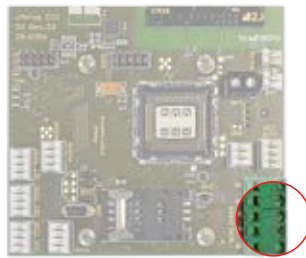
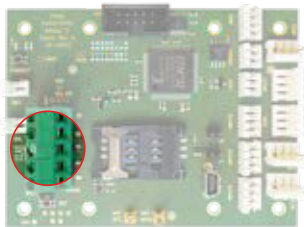

TECHNICAL SPECIFICATIONS

General information

Display shows actual data by pressing the button. It works with iMETOS 3.3 and iMETOS ECO D3

Cable length

5 m standard, custom cable lengths available upon request

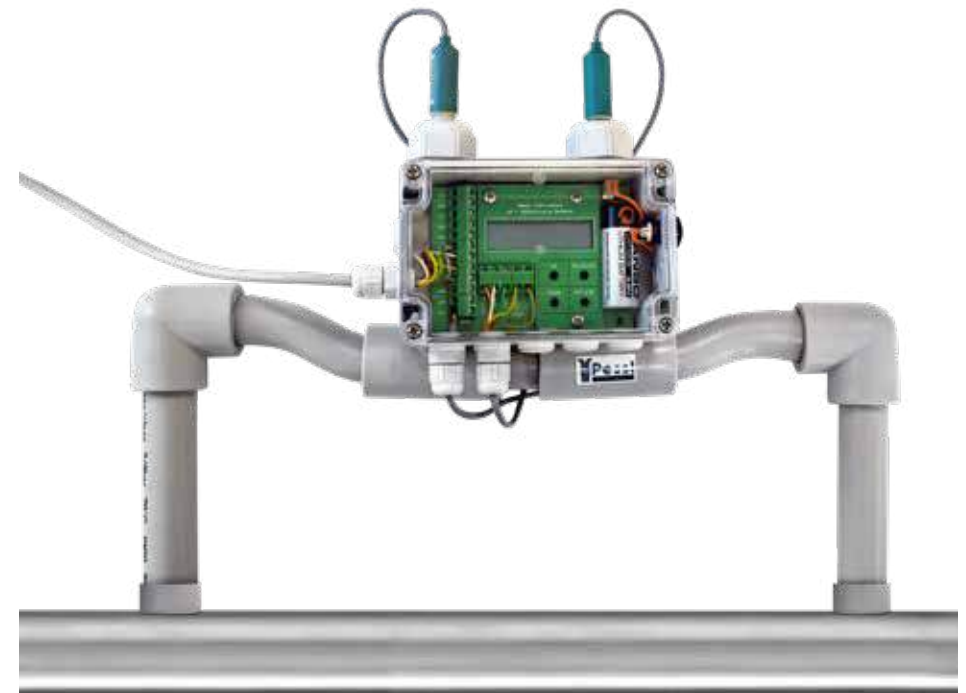

Pessl Instruments Electrical Conductivity

Order number: EC501

The conductivity sensor provides a complete self contained measurement. The sensor utilizes a reliable and robust sensor for conductivity measurement and a thermistor for temperature measurement. The sensor is ideal for hydrographical and environmental water monitoring, in agriculture and industrial applications. The durable design ensures suitability for the harshest environment applications.



TECHNICAL SPECIFICATIONS

Range	0.1 μ S/m - 1000 mS/cm
Resolution	0.1 μ S/cm
Temperature compensation	Automatic
Probe material	PP
Probe diameter	12 mm
Min. immersion	40 mm

INTERFACE

Necessary Interface to connect this sensor with iMETOS:
EC500PH Interface box with display

Pessl Instruments pH Sensor

Order number: PH501

The pH sensor is a reliable and cost-effective sensor for measuring the pH value of various aqueous solutions. The pH scale covers values between 0 and 14.

Acids have pH values between 0 and 6; caustic solutions have pH values between 8 and 14. Value 7 is neutral.



TECHNICAL SPECIFICATIONS

Range	pH 0.00 to 14.00
Resolution	0.001 pH
Accuracy	\pm 2 % F.S.
Temperature deviation	3 % (range 5 °C to 30 °C)
pH probe	Standard up to 0.1 bar (other types on request), 3 m cable, 2-ring-flow-through (please specify type of application)
pH calibration	2-point with automatic buffer (recognition pH 4.0 and pH 7.0)
Probe material	Glass
Probe diameter	12 mm
Min. immersion	35 mm
Operating temperature range	15 °C to 60 °C
Response time	\leq 90 s

INTERFACE

Necessary Interface to connect this sensor with iMETOS:
EC500PH Interface box with display

Pessl Instruments Pressure Switch

Order number: PS-0,5BAR

Simple and robust design makes pressure switch suitable for use with compressed air, hydraulic oil, oil emulsions and water. Detection threshold is 0.5 bar (7.25 psi) and switch off is at 0.25 bar (3.62 psi) (other values on demand). The main purpose of this sensor is to control/check the performance of the irrigation system in different types of applications (resistance to high pressure makes it usable also for frost protection system).



TECHNICAL SPECIFICATIONS

Material	Zinc-plated steel (G 1/4")
Switching function	Open contact, closed contact, changeover
Media	Water, compressed air, hydraulic oil, oil emulsion
Maximum medium temperature	+85 °C
Adjustment ranges	1 to 10 bar (1.4-14 psi), 0-1 bar
Switching frequency	max. 200 /min
Switching pressure difference	10 to 15 %
Switching voltage	Open contact/closed contact 42V max. 2A; Changeover 250 V max. 2A

CONNECTION TO MOTHERBOARDS

iMETOS 3.3

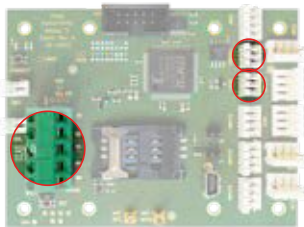

iMETOS ECO D3

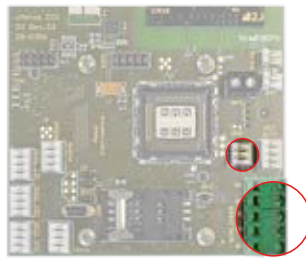

µMETOS NB-IoT/SOIL

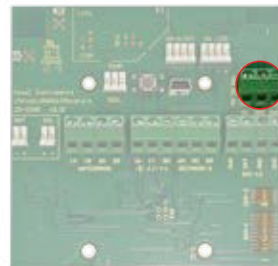

Pessl Instruments Water Counter Interfaces

Order number: SW1000 / SW1010

These interfaces supports most of the water meters used in irrigation with a pulse output.

Applications: Irrigation management, irrigation consulting, smart irrigation, irrigation tractability and book keeping, alarms and supervision. Used widely in open field crops, hydroponics and green house.

SW1000 pulse counter (Reed/Rain input)



SW1010 PI-bus

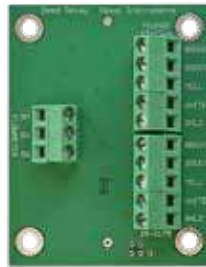

iMETOS 3.3

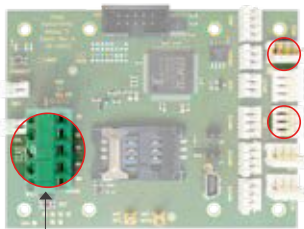

iMETOS ECO D3

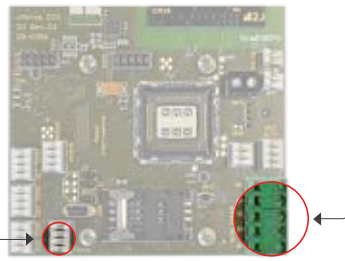

TECHNICAL SPECIFICATIONS

Resolution	0.1 / 1 / 10 / 100 / 1000 liters per pulse
-------------------	--



μMETOS NB-IoT/CLIMA/SOIL (rain input)

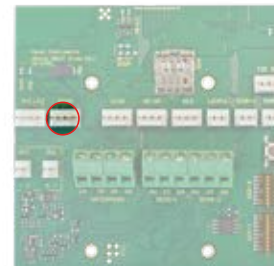

To connect water meter to μMETOS, RFRN09 or RFRN12 boards, no additional interface is needed.

Pessl Instruments Pipe Pressure (WPS)

Order number: WPS

This sensor enables continuous monitoring of the pressure in irrigation pipes (main pipe or sector pipes) and it measures up to 10 Bar (145 psi), so it can be used in all types of irrigation systems (drip irrigation, sprinkler, hydroponics ...). It is easy to install it under the supervision of your irrigation system installer. The main body and the diaphragm of the ceramic thick-film sensor are made of a corrosion-resistant ceramic.

Applications: Irrigation monitoring and supervision, identification of pressure loss in the installation.



TECHNICAL SPECIFICATIONS

Range	0 to 100 m of water column
Resolution	10 mbar
Accuracy	0.3 %
Operating temperature range	0 °C to 50 °C
Storage temperature range	-20 °C to 80 °C
Weight	300 g (including cable)
Housing	POM
Diaphragm	Ceramic
Cable sheath	Shielded PVC
Output signal	Serial (RS485)
Support	PI-bus only at the end of the chain
Dimensions gauge shaft	90 x 20 mm (height x diameter)

CONNECTION TO MOTHERBOARDS

iMETOS 3.3

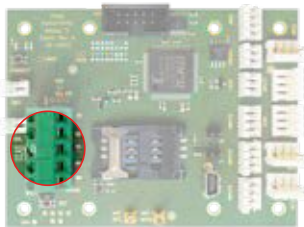

iMETOS ECO D3

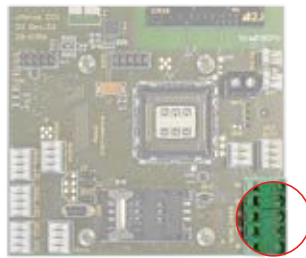

µMETOS NB-IoT/SOIL

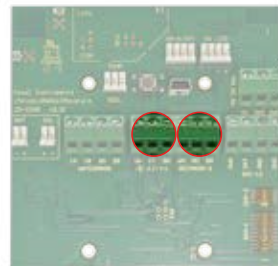

Pessl Instruments Water Level Sensor

Order number: LMP306/15M / LMP305/25M

The Water level sensor is an accurate and cost effective submersible water level sensor that can be connected to iMETOS stations with the precision of 3 mm within the measurement ranges. Sensor has an integrated barometric sensor module to increase precision. Pressure (Measuring) ranges: 0 mWC up to 5 mWC (other distances on request). Special cable is also available.

Applications: Depth or level measurement in wells and open waters (rivers and lakes) and ground water level measurement.



CONNECTION TO MOTHERBOARDS

iMETOS 3.3

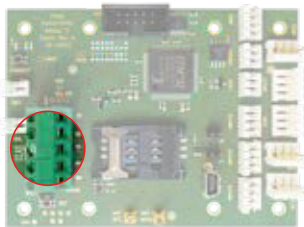

iMETOS ECO D3



µMETOS NB-IoT/SOIL

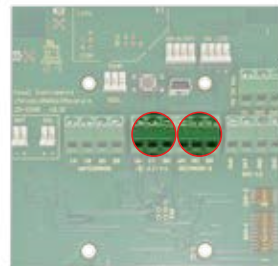

TECHNICAL SPECIFICATIONS

Accuracy according to IEC 60770	Limit point adjustment (nonlinearity, hysteresis and repeatability) within ± 3 % within the measurement ranges
Response time	~ 5 ms
Range	0 to 20 m of water column (other on request)
Resolution	1 mm
Accuracy	0.5 % of maximum water level
Operating temperature range	0 °C to 50 °C
Storage temperature range	-20 °C to 80 °C
Weight	1.1 kg (including cable)
Housing	Stainless steel 1.4301
Diaphragm	Ceramic
Seals	FKM
Cable sheath	Shielded PVC
Output signal	Serial (RS485)
Support	PI-bus only at the end of the chain
Dimensions gauge shaft	90 x 20 mm (height x diameter)



Pessl Instruments Tank Level Sensor

Order number: LMP307/10M

The tank level sensor is an accurate and cost effective submersible water level sensor that can be connected to iMETOS stations with the precision of 3 mm within the measurement ranges. Sensor has an integrated barometric sensor module to increase precision. Pressure (Measuring) ranges: 0 mWC up to 5 mWC (other distances on request). Special cable is also available.

Applications: Tank level monitoring, sensor made from stainless steel and can be used in **corrosive environments**, such as fertilizer tanks, to monitor the level of fertilizer mixture.



CONNECTION TO MOTHERBOARDS

iMETOS 3.3

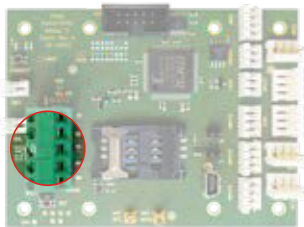

iMETOS ECO D3

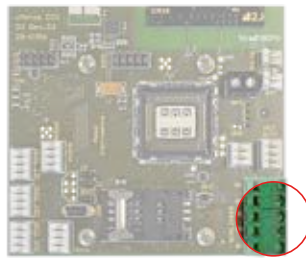

µMETOS NB-IoT/CLIMA/SOIL

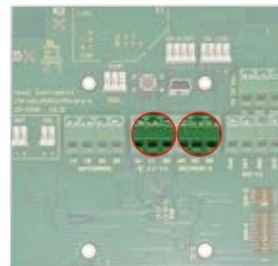

TECHNICAL SPECIFICATIONS

Accuracy according to IEC 60770	Limit point adjustment (nonlinearity, hysteresis and repeatability) within ± 3 % within the measurement ranges
Response time	~ 5 ms
Range	0 to 20 m of water column (other on request)
Resolution	1 mm
Accuracy	0.5 % of maximum water level
Operating temperature range	0 °C to 50 °C
Storage temperature range	-20 °C to 80 °C
Weight	1.1 kg (including cable)
Housing	Stainless steel 1.4571
Diaphragm	Ceramic
Seals	FKM
Cable sheath	Shielded PVC
Output signal	Serial (RS485)
Support	Pessl Instruments BUS only at the end of the chain
Dimensions gauge shaft	90 x 20 mm (height x diameter)



Pessl Instruments Ultrasonic Snow Height or Water Depth Sensor

Order number: USH8

Ultrasonic snow depth sensor is used for non-contact measurements of snow depth and river levels in extreme weather conditions. The sensor is characterized by its high level of operating reliability, low energy consumption, fast installation and ease of use in the field.



TECHNICAL SPECIFICATIONS

Range	0 to 10 m
Resolution	10 mm
Accuracy	0.5 % (FS)
Measurement principle	Ultrasonic
Temperature measurement range	-40 °C to +60 °C
Digital RS-232 interface	Serial port protocol, distance or snow depth
Power supply	From the input of the iMETOS, in areas with limited sun extended battery is needed (ord. no. USH8-BATT-EXT).
Ingress protection	IP 66



CONNECTION TO MOTHERBOARDS

iMETOS 3.3

iMETOS ECO D3

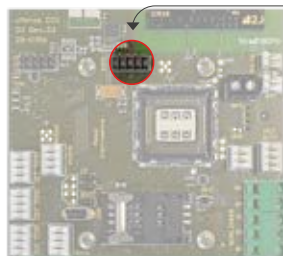
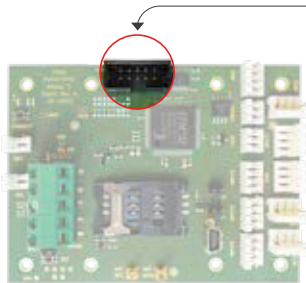

To connect Snow Depth Sensor to the motherboard, you will need **MOD BUS** interface.

Pessl Instruments Pyranometer

Order number: IM506D

The IM506D Pyranometer is designed for field measurements of global solar radiation in agricultural, meteorological and solar energy studies. In clear, unobstructed daylight, the Pessl Instruments pyranometer has favourable results compared to the first class thermopile-type pyranometers, but is priced at just a fraction of the cost.

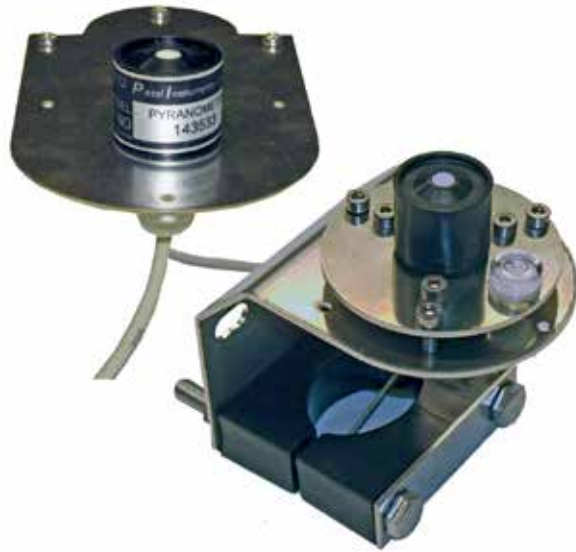

CONNECTION TO MOTHERBOARDS

iMETOS 3.3

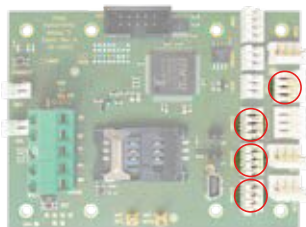

iMETOS ECO D3

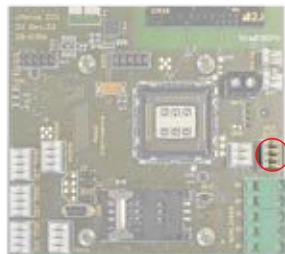

µMETOS NB-IoT/CLIMA

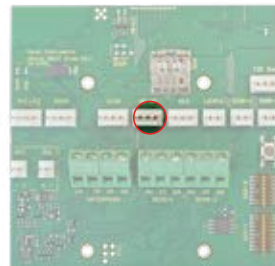

TECHNICAL SPECIFICATIONS

Sensor	LI-200SZ
Calibration	Calibration against Kipp & Zonen CMP3 under daylight. Absolute error max. 5 %, typically 3 %
Stability	2 % drift on 2-year use
Time to measure	10 µs
Temperature dependency	0.15 % per °C
Cosines correction	Sensor corrects up to 80° degrees
Azimuth	1 % error over 360 degree at 45 degree elevation
Operating temperature range	-20 °C to 65 °C
Operating relative humidity range	0 to 100 %
Sensor	Photodiode
Housing	Weatherproof PAS case with acrylic diffuser, stainless steel hardware
Size	35 mm diameter, 45 mm height
Weight	114 g
Evaluation	Pulse Wide Modulation 0-80 % = 0-2000 W/m ²
Spectral range	300-1100 nm

Pessler Instruments PAR Quantum

Order number: IM507D

Photosynthetically Active Radiation (PAR) is typically measured as Photosynthetic Photon Flux Density (PPFD), which has units of quanta (photons) per unit of time per unit of surface. The units most commonly used are micromoles of quanta per second per square meter ($\mu\text{mol s}^{-1} \text{m}^{-2}$). Plant scientists, horticulturists, ecologists, and other environmental scientists use MD507D Quantum Sensors to accurately measure this variable.



CONNECTION TO MOTHERBOARDS

iMETOS 3.3

μ METOS NB-IoT/CLIMA

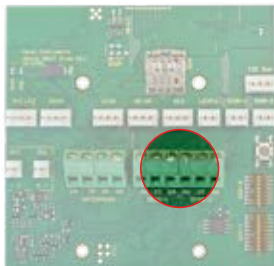
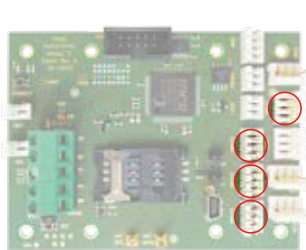

TECHNICAL SPECIFICATIONS

Sensor	EG&G VACTEC VTB1012B
Calibration	Calibration against LI-190SZ under daylight. Absolute difference max. 5 %, typical 3 %
Linearity	Maximum deviation of 1 % up to 3000 W/m ²
Stability	2 % change over a 1 year period
Response time	150 ms
Temperature dependency	0.15 % per °C
Cosines correction	Sensor corrects up to 80° degrees
Azimuth	1 % error over 360 degree at 45 degree elevation
Operating temperature range	-20 °C to 65 °C
Operating relative humidity range	0 to 100 %
Sensor	Photodiode
Housing	Weatherproof PAS case with acrylic diffuser, stainless steel hardware
Size	35 mm diameter, 45 mm height
Weight	114 g
Evaluation	PWM: 0-80 % duty cycle = 0-20 kJ/m ²

Pessl Instruments Lux Meter

Order number: IM508D

Photometry or Luxmeter IM508D refers to the measurement of visible radiation (light) with a sensor having a spectral responsivity curve equal to the average human eye. The sensor is used to measure lighting conditions where the eye is the primary receiver, such as illumination of work areas, greenhouses, interior lighting etc.

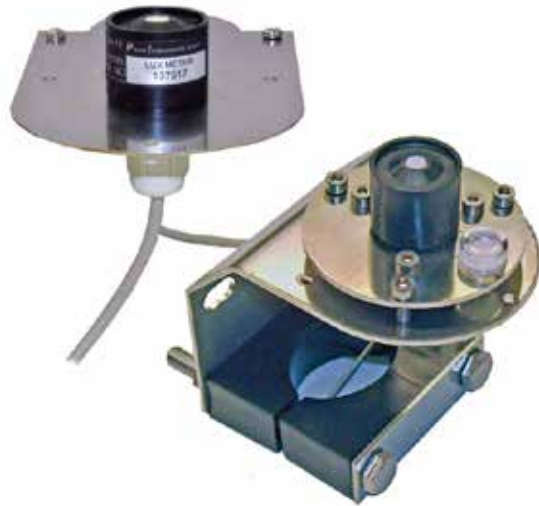

CONNECTION TO MOTHERBOARDS

iMETOS 3.3

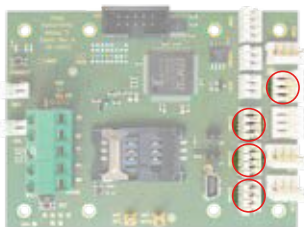

TECHNICAL SPECIFICATIONS

Sensor	VTB 1012 HB
Calibration	Skye SKL 310
Stability	5 % drift on 2 years use
Time to measure	250 ms
Temperature dependency	0.15 % per °C
Cosines correction	Sensor corrects up 80 to degrees
Direction error	1 % through 360 degrees at 45°
Operating temperature range	-20 °C to 65 °C
Operating relative humidity range	0 to 100 %
Sensor	Photodiode
Housing	Weatherproof PAS case with acrylic diffuser, stainless steel hardware
Size	35 mm diameter, 45 mm height
Weight	114 g
Evaluation	Pulse Wide Modulation Output 8.18 % pulse wide at 0 Lux 91.82 % pulse wide at 80 000 Lux
Spectral range	330-730 nm, Peak at 580 nm Par Quantum

Hukseflux LP02 Heat Flux Plate

Order number: LP02

LP02 serves to measure the heat that flows through the object in which it is incorporated or on which it is mounted. The actual sensor in LP02 is a thermopile, which measures the differential temperature across its ceramics-plastic composite body. Working completely passively, LP02 generates a small output voltage proportional to the local heat flux.



TECHNICAL SPECIFICATIONS

Sensitivity (nominal)	15 $\mu\text{V}/\text{Wm}^2$
Operating temperature range	-40 °C to +80 °C
Range	0 to 2000 Wm^2
Calibration traceability	to WRR

CONNECTION TO MOTHERBOARDS

iMETOS 3.3

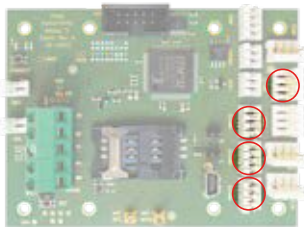

iMETOS ECO D3

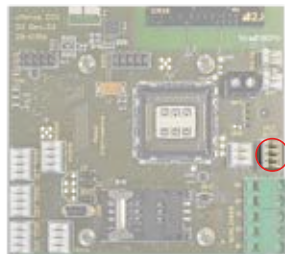

Pessl Instruments Barometer

Order number: MD514D

The Pessl Instruments barometric sensor measures the “absolute air pressure” of the atmosphere on site. It is designed for application of environmental protection, where high accuracy, quick response, long term stability and reliability are required. The instrument is suitable for indoor and outdoor use. A tempered piezoceramic sensor for absolute pressure is used, characterized by its thermal and mechanical stability.



TECHNICAL SPECIFICATIONS

Working range	0-1150 mbar
Weight	ca. 50 g
Power supply	5.0 VDC (6 VDC maximum)
Zero offset	0.50 ±0.09 VDC
Power uptake	max. 20 mA
Precision	0.1 % max. Thrift
Temperature range	-40 °C to 125 °C
Measuring type	Serial (RS 485)

CONNECTION TO MOTHERBOARDS

iMETOS 3.3

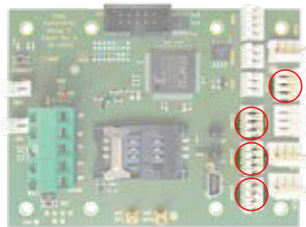

iMETOS ECO D3

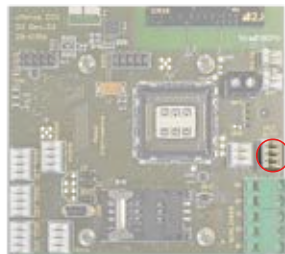

µMETOS NB-IoT/CLIMA

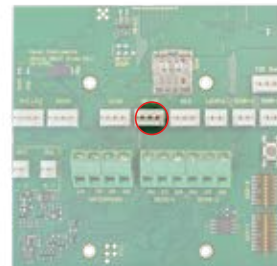

Pessl Instruments Dendrometer

Order number: DN502, DN503, DN504

Dendrometers are sensors for continuous measurement of plant growth (changes of the plant diameter). The dendrometer allows us to record the plant parameters using the same time interval as environmental parameters. The data allows the direct assignment of plant responses and stress to environmental influences. Dendrometers are a cost-effective and useful tool for ecophysiological studies.



CONNECTION TO MOTHERBOARDS

iMETOS 3.3

iMETOS ECO D3

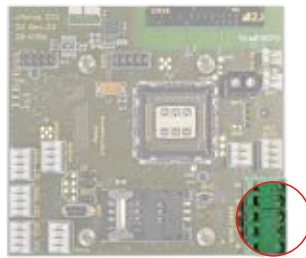
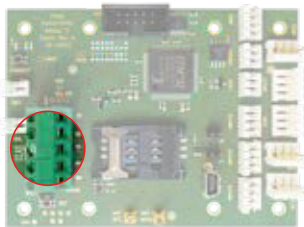

TECHNICAL SPECIFICATIONS

To specify plant size range	Diameter 3-30 cm
Range of the sensor	11 mm
Accuracy	$\pm 1.5 \mu\text{m} \pm 0.12 \%$ (CR1000 Logger)
Resolution	0.2-2.6 μm (dependent on used data logger)
Linearity	1 %
Thermal expansion coefficient of the sensor	$< 0.1 \mu\text{m/K}$
Operating temperature range	-25 to 70 °C
Operating relative humidity range	0 to 100 %

INTERFACE

Necessary Interface to connect this sensor with iMETOS:
DN501

Yara Water Sensor

Order number: YARA-WS

The Yara Water Sensor measures changes in the leaf's turgor pressure of the plant. As the turgor pressure is the driving force for plant growth and fruit production, proper water management is the key.

- Plant-based, continuous and non-destructive measurement of plant water status
- Online data transmission and web-based access via MyYara
- Automatic, validated crop-specific irrigation-recommendation in combination with MegaLab from Yara with nutrition advice



CONNECTION TO MOTHERBOARDS

iMETOS 3.3

iMETOS ECO D3

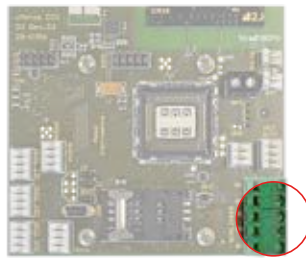
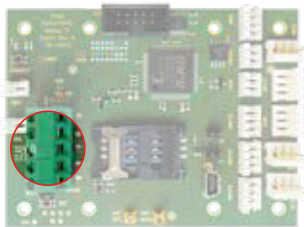

The Yara Water Sensor is designed for use during several seasons. The durability also depends on environmental conditions during the use and will be determined by:

- Intensity of UV radiation
- Contact with fertilizers and pesticides
- Contact with secretions of the plant
- Mechanical damage
- Temperature

TECHNICAL SPECIFICATIONS

Temperature range	5 °C to 60 °C
Connection cable	Length ca. 2 m
Delivery contents	Yara Water Sensor/documentation Mounting clips for wire

CROP

Olive	Big one (5.0 mm)
Citrus	Big one (5.0 mm)
Grapevine	Depending on variety and location; preferably use the small one (2.5 mm)
Cherry	Small one (2.5 mm)
Apple	Small one (2.5 mm)

INTERFACE

Necessary Interface to connect this sensor with iMETOS:

ECH870EXT, ECH871EXT, ECH874EXT or ECH870INT, ECH871INT, ECH874INT or RFRN09, RFRN12, RFRN13



To connect Yara Sensor to the motherboard, you will need a Yara interface.

Interfaces



iMETOS RadioNode Interface

iMETOS RadioNode is a small, wireless, battery powered datalogger for in-field measurement of soil moisture, temperatures, rain, flow rate, leaf wetness, relative humidity and other parameters. iMETOS RadioNode sends all sensor readings in real time through an interactive star topology network back to our base station. From the base station, the data is uploaded to the web via cellular network (GPRS, UMTS, WiFi). All data is available through FieldClimate platform. To connect iMETOS RadioNode to the iMETOS 3.3, RF Access Point is needed.

TECHNICAL SPECIFICATIONS

Housing	UV resistant polycarbonate plastic (Protection class IP67)
Dimensions without sensors	30 cm L x 16 cm W x 19 cm H
Weight without sensors	1.6 kg
Model/Type	Texas Instruments RF CC1120 module with integrated ultra low power sub-GHz; transceiver module; integrated crystal, internal voltage regulator, built in antenna global; using free ISM bands, ISM Band 915 MHz: USA, Canada, Australia, Israel etc.; ISM Band 868 MHz: Europe; ISM Band 433 MHz: Asia
Expected range	300 to 400 meter (1200 to 1400 ft.) at +10 dBm, broad line of sight, when mounted on level ground at least 3 m (10 ft.) high and above crops, grass, bushes or foliage

CONNECTION TO MOTHERBOARDS

iMETOS 3.3/ μ METOS NB-IoT/CLIMA/SOIL

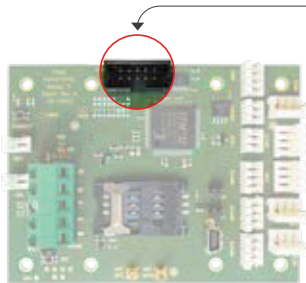

Internal wireless access point allows you to connect up to 16 RadioNodes to the main station.

Remote Sensor Node Variations

RFNR09 iMETOS RadioNode Climate with inputs for:

1. Rain gauge 0.2 mm (0.01 inch) / Water meter
2. Pressure switch / Leaf wetness sensor
3. Hydroclip - Temperature and relative humidity sensor
- 4 & 5. Temperature sensor
- 6 & 7. Watermark sensor
- 8 & 9. PI54-D/METER sensor

Power Supply: One 3.6V Li-Ion primary cell with 19.000mAh (7 years operation)

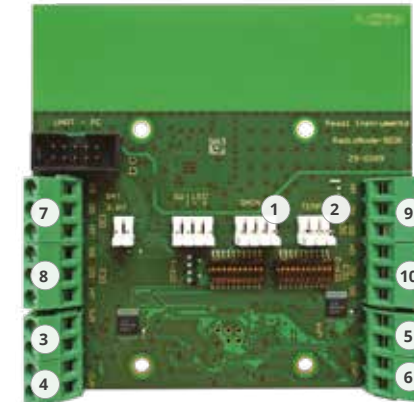
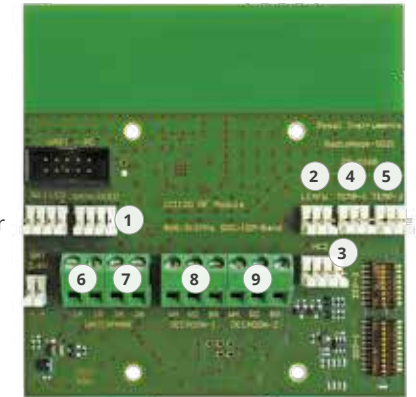

RFNR12 iMETOS RadioNode Watermark/METER with inputs for:

1. Rain gauge 0.2 mm (0.01 inch) / Water meter
2. Temperature sensor (WMTEMP)
- 3.-6. Watermark sensor
- 7.-10. PI54-D/METER sensor

Power Supply: One 3.6V Li-Ion primary cell with 19.000mAh (7 years operation)

RFNR13 iMETOS RadioNode Drill & Drop with inputs for:

1. Rain gauge 0.2 mm (0.01 inch) / Water meter
2. Sentek Drill & Drop probe
- 3.-4. Watermark sensor
- 5.-6. PI54-D/METER sensor
7. Solar panel
8. 6V, 4.5Ah battery connector
9. External antenna

Power Supply: Solar panel and 6V Pb 4.5Ah battery

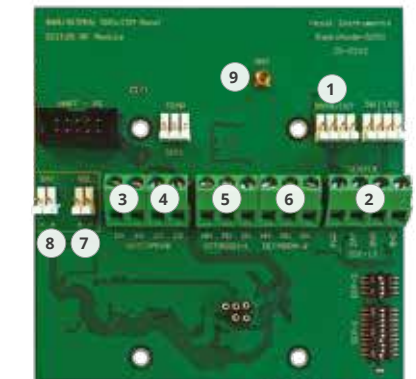

Chain Node Interface for 3 Pessl Instruments Sensors

Order number: ECH870EXT / ECH870INT

This Interface enables the connection of up to 3 Pessl Instruments soil sensors to an iMETOS weather station.

The Interface can be an External box for iMETOS 3.3 (ECH870EXT) or Internal for iMETOS ECO D3 (ECH870INT).



YOU CAN CONNECT:

The following Pessl Instruments sensors:

- Vacuum Tensiometer
- Water Level Sensor
- Pipe Water Pressure Sensor
- PI54-A
- PI54-D

CONNECTION TO MOTHERBOARDS

iMETOS 3.3

iMETOS ECO D3

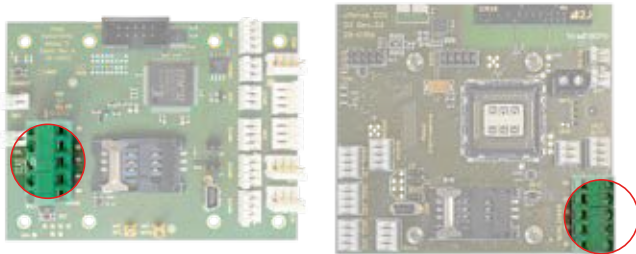

Chain Node Interface for 2 Pessl Instruments Sensors & 2 Watermark Sensors & 1 Soil Temperature Sensor

Order number: ECH871EXT / ECH871INT

This Interface enables the connection of up to 5 soil sensors to an iMETOS weather station. It is possible to connect 2 Pessl Instruments sensors, 2 Watermark sensors and 1 soil temperature sensor.

The Interface can be an External box for iMETOS 3.3 (ECH871EXT) or Internal for iMETOS ECO D3 (ECH871INT).



YOU CAN CONNECT:

Two pieces of the following sensor:

- Watermark sensor

One piece of the following sensor:

- Soil Temperature (WMTEMP)

Two pieces of the following Pessl Instruments sensors:

- Vacuum Tensiometer
- Water Level Sensor
- Pipe Water Pressure Sensor
- PI54-A
- PI54-D

CONNECTION TO MOTHERBOARDS

iMETOS 3.3

iMETOS ECO D3

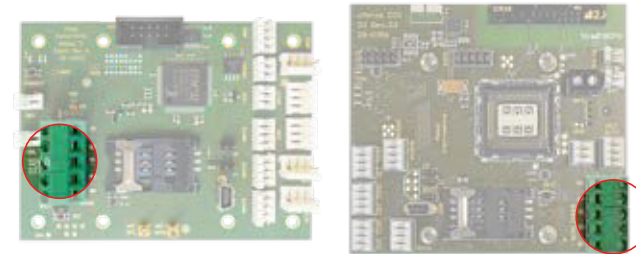

Chain Node Interface for 1 Pessl Instruments Sensor & 4 Watermark Sensors & 1 Soil Temperature Sensor

Order number: ECH874EXT / ECH874INT

This Interface enables the connection of up to 6 soil sensors to an iMETOS weather station. It is possible to connect 1 Pessl Instruments sensor, 4 Watermark sensors and 1 soil temperature sensor. The Interface can be an External box for iMETOS 3.3 (ECH874EXT) or Internal for iMETOS ECO D3 (ECH874INT).



YOU CAN CONNECT:

Four pieces of the following sensor:

- Watermark sensor

One piece of the following sensor:

- Single Soil Temperature

One piece of the following

Pessl Instruments sensors:

- Vacuum Tensiometer
- Water Level Sensor
- Pipe Water Pressure Sensor
- PI54-A
- PI54-D

CONNECTION TO MOTHERBOARDS

iMETOS 3.3

iMETOS ECO D3

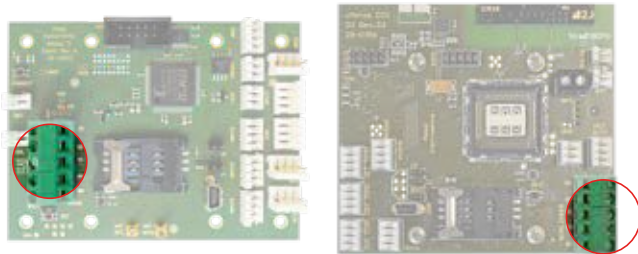

Chain Node Interface for 3 Watermark Sensors and 1 Soil Temperature Sensor

Order number: WM-BUS / WM-BUSINT

This Interface enables the connection of 3 Watermark sensors and 1 soil temperature sensor.

The Interface can be an External box for iMETOS 3.3 (WM-BUS) or Internal for iMETOS ECO D3 (WM-BUSINT).



YOU CAN CONNECT:

Three pieces of the following sensor:

- Watermark sensor

One piece of the following sensor:

- Soil Temperature

CONNECTION TO MOTHERBOARDS

iMETOS 3.3

iMETOS ECO D3

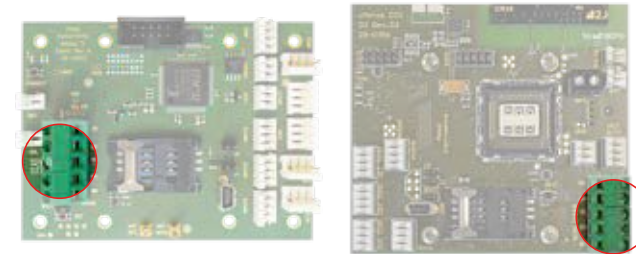

SDI12 Chain Node Interfaces with 2 iMETOS AC/Sentek Connectors

Order number: SDI12_Chain / SDI12_X2

These Interfaces enable the connection of up to 2 iMETOS AC or 2 Drill & Drop probes. The Interface can be an External box for iMETOS 3.3 (SDI12_Chain) or Internal for iMETOS ECO D3 (SDI12_X2).

YOU CAN CONNECT:

Two pieces of the following probe:

- iMETOS AC different types
- Sentek Drill & Drop different types

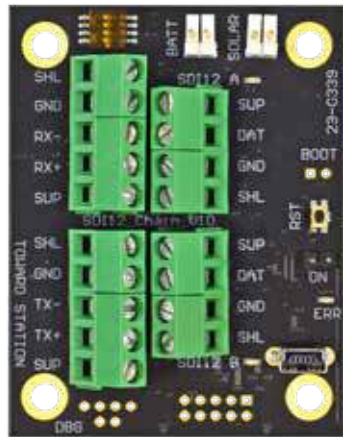

SDI12_Chain
External Chain Interface



SDI12_X2 Internal Interface
for 2 Soil Moisture Probes

CONNECTION TO MOTHERBOARDS

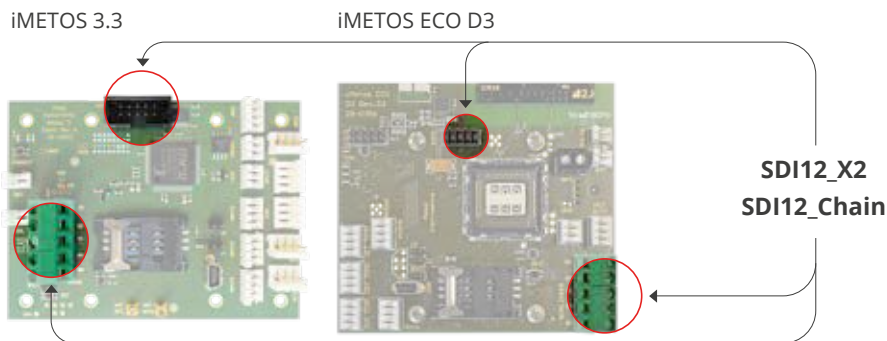

MF 400 IoT Satellite Bridge - SATELLITE CONNECTIVITY FOR REMOTE PESSL INSTRUMENTS LoRaWAN™ SENSORS

The MF 400 IoT Satellite Bridge provides network server connectivity for remote Pessl Instruments LoRaWAN™ sensors via Inmarsat IsatDataPro (IDP) satellite terminal and can operate continuously from a single 80W solar panel. The MF 400 runs an optimized protocol to ensure that airtime satellite costs per sensor are kept to a minimum. This makes the MF 400 IoT Satellite Bridge a stand alone, low power, low cost solution for adding satellite connectivity to your existing COTS LoRaWAN™ sensor devices.

- Global coverage with the Inmarsat IsatData Pro satellite network
- Runs continuously off single 80W solar panel
- Compatible with Pessl Instruments LoRaWAN™ sensors
- Water and rain proof (IP-67)
- Cloud based interface and API for remote LoRaWAN™ configuration (no field visits required for reconfiguration)

Components:

- MinFarm IoT Satellite Bridge
- CPN IP67 Enclosure (400 x 405 x 160mm)
- 12V 26Ah Battery
- STECA PR 1010 Solar Charger
- 80W 12V Solar Panel (670 x 770 x 30mm)
- LoRaWAN™ Omnidirectional Antenna (8dBi, 0.8m)
- Enclosure Pole Mount
- Solar Panel Pole Mount
- LoRaWAN™ Antenna Pole Mount
- IDP Satellite Terminal Power & Data Cable (5m)
- Solar Panel to Enclosure Cable (5m)
- LoRaWAN™ Antenna Cable (5m)

The following components can also be supplied:

- IDP ST 6100 Satellite Terminal
- IDP Pole Mount



Ease of Installation

The solar power management system contains a helpful display that shows all the important operational metrics including voltage, current and battery capacity. This allows an installer to see at a glance that the solar panel is working and correctly charging the battery.

Innovative cabling design for the IDP terminal

The MF 400 IoT Satellite Bridge features an integrated power and data cable for the IDP terminal. The cable is securely attached to the MF 400 and allows the IDP to be connected up to 5m from the MF 400 to achieve optimal satellite reception. The IDP terminal is powered by the MF 400 and the MF 400 communicates with the IDP terminal using AT commands. No extra cabling or power components are required.

Autonomous Solar Power

The MF 400 IoT Satellite Bridge runs continuously from its single 80W solar panel. The unit's 12V 26Ah Battery provides up 2-3 days of battery backup capacity.

Temperature Range: -10°C to 40°C (Temperate model*)

*Extended temperature models of the MF 400 IoT Satellite Bridge that use different battery and power management components are available, please contact MinFarm for more information.

Satellite airtime costs per sensor

The MF 400 IoT Satellite Bridge is optimized to transmit data from LoRaWAN™ IoT sensors over the Inmarsat IDP satellite link in an extremely reliable and low cost way. It does so by a client/server bridge architecture. The MinFarm Bridge Client (see Network Architecture diagram) forwards sensor payload traffic over non-IP packet data satellite services of Inmarsat IDP. This makes the MF 400 IoT Satellite Bridge an extremely cost effective way to add satellite connectivity to remote LoRaWAN™ sensor installations.

NETWORK ARCHITECTURE

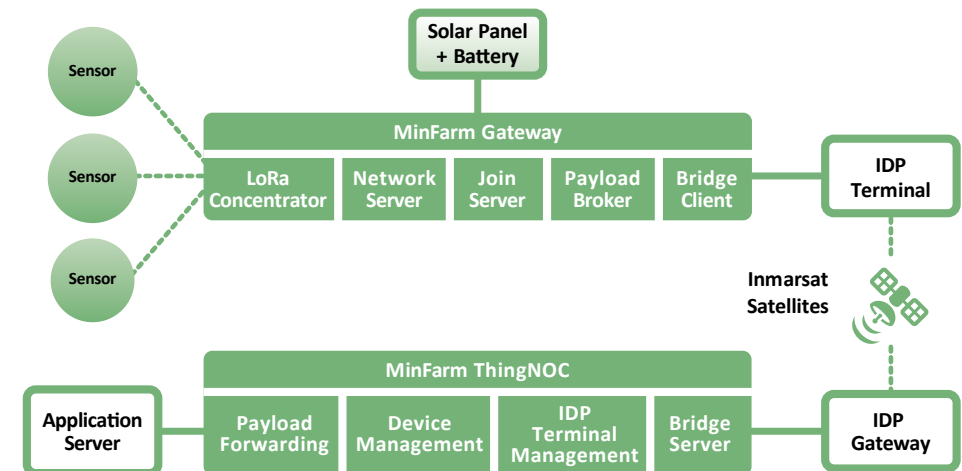

Compatible sensors

The MF 400 IoT Satellite Bridge supports LoRaWAN™ version 1.0.2. The MF 400 IoT Satellite Bridge is compatible with LoRaWAN™ sensors by Pessl Instruments.

GNSS Specifications

GNSS Systems: GPS, QZSS, SBAS, GLONASS

LoRaWAN™ Specifications

Supports multiple regional frequency plans: EU868, US915, AU915, AS923 (Other frequency plans available on request)

Channel Capacity: 8 channels

LoRaWAN™ Power Output: 27 dBm maximum output power before antenna

Software & Services



FieldClimate Platform & iMETOS Documentation

FieldClimate PLATFORM



ng.FieldClimate.com



VISIT METOS.AT FOR EXTENSIVE iMETOS DOCUMENTATION

We are constantly updating and adding relevant content about disease models, weather forecast, irrigation management and other services, along with technical documentation and answers to frequently asked technical questions.



www.metos.at

Our Mobile Applications

FieldClimate MOBILE APP



FieldClimate platform and mobile app are free of charge and are included in the hardware price of all METOS devices.

FarmView

THE PREMIUM SERVICE IN FieldClimate

By measuring weather conditions, soil moisture and tracking your vehicles on the ground, you can monitor the complete situation in your field. FarmView enables you to view and sort all your data at the level of your farm, field or cropzone.

Farmview also enables you to record the irrigation and read the evapotranspiration status and thus view the daily water balance relevant for your field. Lastly, it lets you view the tracker data and plant protection recordings and combine them with the fungal disease models and with insect trapping devices.

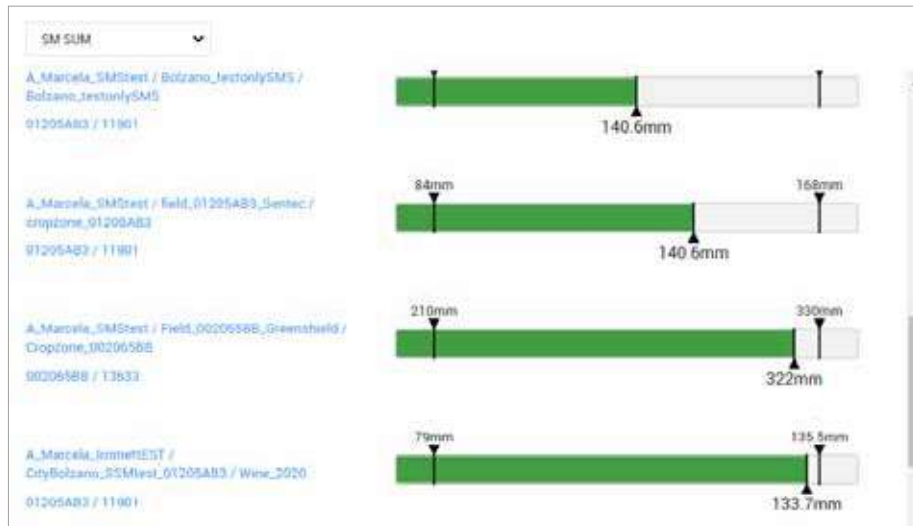

Available data related to your farm, field and cropzone

- **Irrimet:**
 - Water balancing,
 - Irrigation recordings
 - Irrigation recommendations
- **Soil moisture in crop and cropzone**
- **Diseases:**
 - Plant disease models
 - Insect population information
- **Tracker**
 - Work reporting
 - Spray quality monitoring
 - Spray date administration
- **Plant nutrition information**

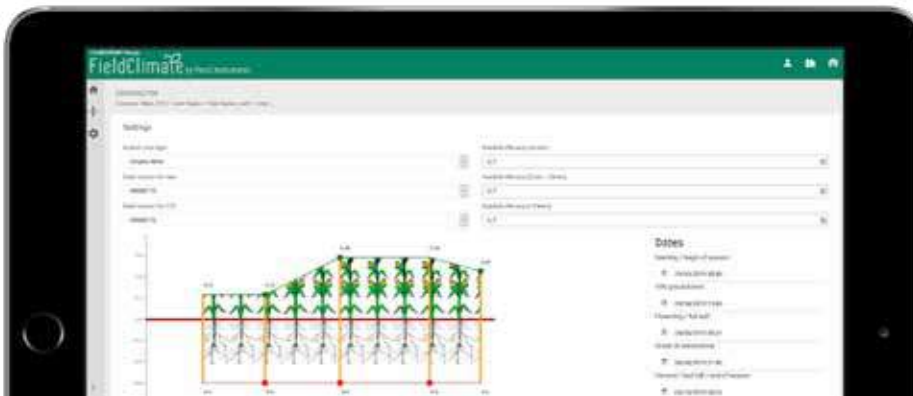

FarmView S

THE PREMIUM SERVICE IN FieldClimate
WITH SATELLITE DATA

FarmView S is an upgraded package of FarmView. It offers you to define your fields and related iMETOS sensors, use all features of Farmview and in addition provides you with an option to display, analyse or upload crop development maps derived from the Sentinel-2 satellite.

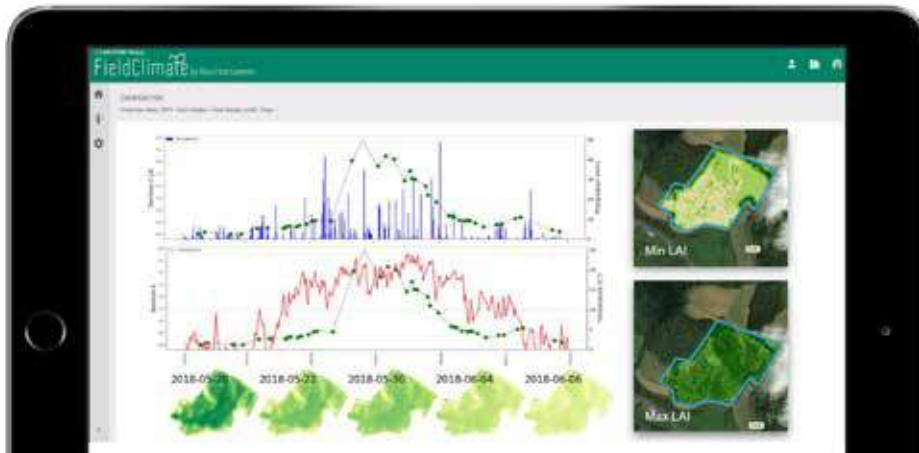
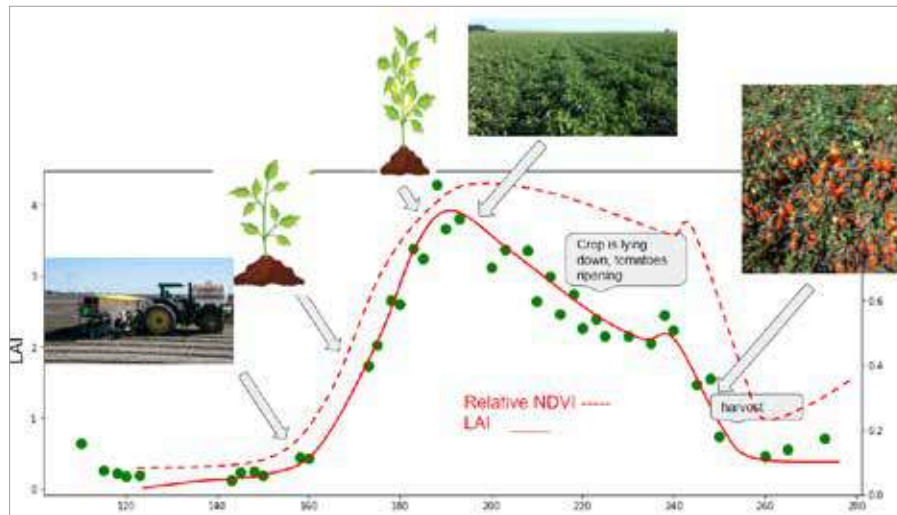

Available data related to your farm, field and cropzone

• Satellite (Sentinel-2):

- Vegetation dynamics
- Detection of effects of weather, fertilizer application, irrigation and plant protection activities
- Automatic plant growth stage detection
- Monitoring of problematic areas

• Irrimet:

- Water balancing,
- Irrigation recordings
- Irrigation recommendations

• Soil moisture in crop and cropzone

• Diseases:

- Plant disease models
- Insect population information

• Tracker

- Work reporting
- Spray quality monitoring
- Spray date administration

• Plant nutrition information

Available new insights from our data

- Soil sampling maps derived from the Sentinel-2 data
- Plant testing maps for DualEX from the Sentinel-2 data
- Plant growth calculations based on Sentinel-2, CropView and Weather data

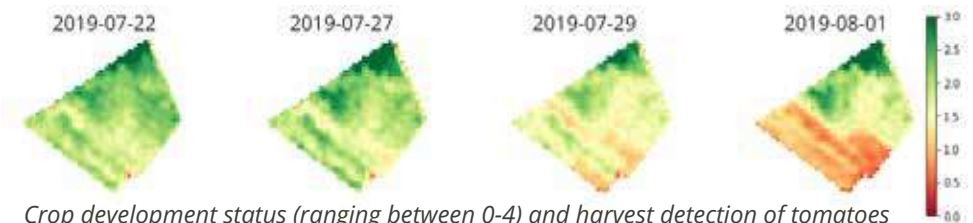

Crop development status (ranging between 0-4) and harvest detection of tomatoes in Turkey, 2019.

Planning Tools

WEATHER FORECAST, WORKFORCE PLANNING,
FIELD ACCESSIBILITY, SPRAY WEATHER

HYPER-LOCAL STATION-CORRECTED WEATHER FORECAST

With iMETOS weather station, you get the best forecast for your farm and fields by: using real-time local measurements to post-correct modeled forecast output, eliminating model bias and updating the forecast frequently with the last data from your station, satellite and radar. Artificial intelligence is further used to increase the models skill and optimally combine/select the best forecast models at any particular location.

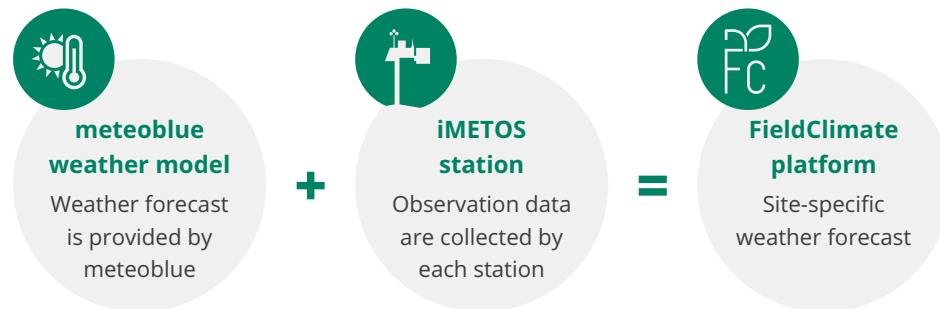

SAVE TIME, INCREASE YOUR YIELDS

A 3 or a 7-day weather forecast of all the important meteorological variables including services such as work planning, animal production and disease risk models, helps:

- **Plan the work week** based on a localised weather forecast for your operations site
- **Better organize your work day** based on the actual rain and temperature data and the hourly updated weather forecast for your field
- **Protect your crop from frost** by monitoring accurate temperature forecasts updated on an hourly basis
- **Optimize and reduce crop treatments** based on site-specific disease models and predictions
- **Plan your fertilization application** with accurate hourly weather forecasts
- **Plan your irrigation** based on actual ET - crop use and predicted plant water use
- **Know the best hours to access your fields** for the next several days based on soil tractability
- **Know when to plant, sow and harvest** your crop considering adequate availability of seed zone soil moisture, optimal temperature and more weather conditions
- **Maximize your yield and quality** with optimized weather risk forecasts of your fields



Disease & Pest Models

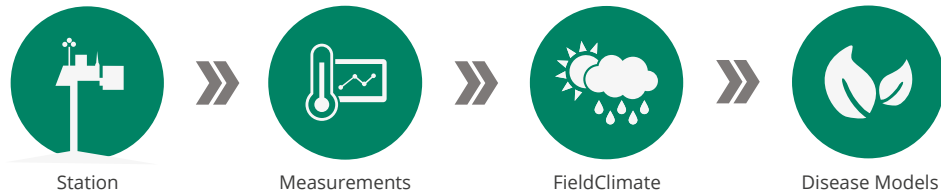

A plant disease model is a mathematical description of interactions among the environment, the host plant and the variables related to the pathogen that can lead to the development of the disease. The more advanced models are those which can predict the impact or severity of the disease and the development of inoculum.

Pessl Instruments models have been developed to provide the best information possible to enable conscious decision making and use the best tools to produce more, both in terms of quantity and quality.

The majority are a result of international scientific cooperation with research institutes and universities over the last 30 years. Having been used by farmers for several years in different climates and environments, they have proven their efficiency over time.

PESSL INSTRUMENTS HAS MORE THAN 80 DISEASE MODELS FOR MORE THAN 35 CROPS, WHICH CAN BE ACCESSED DIRECTLY THROUGH THE ng.fieldclimate.com PLATFORM.



To offer full support for plant protection management, we collaborate with the Swiss partner meteoblue. Plant disease models are thus based on highly precise weather forecast which is localized and calibrated on the monitoring site. A forecast of all the main meteorological variables and other agronomic information, such as the window for phytosanitary interventions, is provided on an hourly basis, for 7 days and updated each time the service is accessed on ng.fieldclimate.com.

WHAT YOU GET:

- **Highly precise weather forecast of all major meteorological variables**
- **Disease model calculation and other agronomic information**
- **Hourly forecast for 7 days**
- **Real time data at the time of accessing the service**

The spray window helps identify suitable periods for the application of crop protection measures by showing suitable (green), less suitable (yellow) and unsuitable (red) periods for application. The conditions are calculated from wind, precipitation, air temperature, relative humidity and delta T.

Spray window



DISEASE MODELS FOR VITICULTURE

- **Downy mildew** (*Plasmopara viticola*) - Primary infection according to Cortesi, Hill et al.; secondary infection according to Arens, Blaser and Gehman; incubation period time according to Mueller and Sleumer)
- **Powdery mildew** (Powdery mildew risk according to Gubler and Thomas and powdery mildew risk modified to take into account the effects of *A. quisqualis*)
- **Grey mould**
- **Black rot**
- **Anthraco nose**
- **Leaf growth** and **rainfall accumulation**
- **Fungicide wash off**
- **Grape berry moth**

Information management in the vineyard is of key importance for the decision-making process. It leads to the production of high quality grapes and is the starting point of the production of fine wines.

We have been helping grape producers and wine experts in the management of their crop for more than 25 years, and were pioneers in producing weather stations capable of calculating disease models for downy mildew of the vine.

The models have been validated through the years of use in the wide range of wine-growing areas.

iMETOS 3.3 and iMETOS D3 provide the raw data (rainfall, leaf wetness, temperature and humidity) that are used in the mathematical calculation of disease models. They are available through the ng.fieldclimate.com platform - for the main plant diseases and insects.

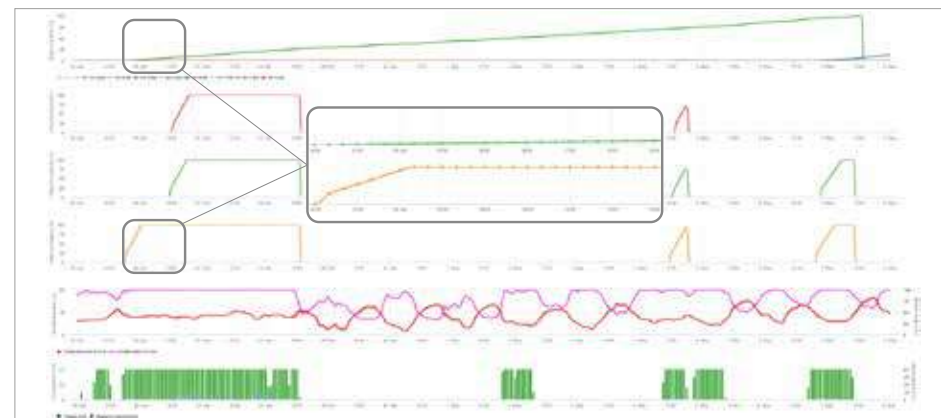

In the graph you can see how a period with rainfall, long intervals of leaf wetness and high relative humidity combined with air temperature is followed by the development of a primary infection of peronospora. When the infection reaches 100%, the model begins to calculate the incubation period for this infection. When 100% incubation is reached, symptoms are visible on leaves (oil spots).

STATIONS & SENSORS

Basic sensor set needed for pest and disease monitoring: air temperature and relative humidity, rain gauge and leaf wetness. In some cases solar radiation, soil temperature and soil moisture sensors are also necessary. You can install these sensors on an iMETOS 3.3 IMT280, iMETOS ECO D3 and μ METOS CLIMA.



Through API, the data from iMETOS stations can be used on web platforms to provide plant disease models and DSS for plant protection.

OTHER DISEASE MODELS

APPLE



- Apple scab (*Venturia inaequalis*)
- Apple Codling moth (*Cydia pomonella*)
- Apple Aphids (*Aphis pomi*, *Dysaphis plantaginea*)
- Stroke of fire blight (*Erwinia amylovora*)
- Rainfall accumulation and leaf growth
- Chilling portions

PEAR



- Pear scab (*Venturia pyrina*)
- Brown spot of pear (*Stemphylium vesicarium*)
- Stroke of fire blight (*Erwinia amylovora*)
- Rainfall accumulation and leaf growth
- Aphid risk
- *Fabraea* leaf spot

STRAWBERRY



- Grey mould (*Botrytis cinerea*)
- Powdery mildew (*Podosphaera aphanis*)
- Rainfall accumulation and leaf growth
- Leather berry (*Phytophthora cactorum*)
- Chilling portions

BLUEBERRY



- Ripe rot (*Colletotrichum acutatum*)
- Rainfall accumulation and leaf growth
- Anthracnose (*Elsinoë veneta*)
- Chilling portions

CHERRY



- Blossom blight (*Monilia laxa*)
- Coryneum Blight (*Wilsonmyces carpophilus*)
- Rainfall accumulation and leaf growth
- *Cladosporium carpophilum* risk
- Powdery mildew risk
- *Taphrina* leaf curl
- Leaf spot (*Blumeriella jaapii*)
- Western flower thrips (*Frankliniella occidentalis*)
- Bacterial cancer (*Pseudomonas syringae*)
- Chilling portions

CITRUS



- Alternaria rot (*Alternaria alternata*)
- *Colletotrichum acutatum*

APRICOT, PRUNE & MIRABELLE



- Pocket or bladder Plum gall (*Taphrina pruni*)
- Rainfall accumulation and leaf growth
- Aphid risk
- *Xanthomonas arboricola* infection
- *Monilinia* risk
- Shot hole wilsonomyes carpophilus
- Powdery mildew risk
- *Taphrina* leaf curl
- Scab / *cladosporium carpophilum*
- Brown rot (*Monilia laxa*)
- Rust infection
- Chilling portions

PEACH



- Peach leaf curl (*Taphrina deformans*)
- Peach Scab (*Cladosporium carpophilum*)
- Rainfall accumulation and leaf growth
- Aphid risk
- *Monilia* risk
- Powdery mildew
- *Sphaerotheca pannosa* risk
- Chilling portions

TOMATO IN OPEN FIELD



- Late Blight (*Phytophthora infestans*)
- *Alternaria alternaria* (TomCast model)
- Root rot (*Phytophthora capsici*)
- Powdery Mildew (*Leveillula taurica*)
- Grey mould (*Botrytis cinerea*)
- Fruit rot
- Powdery mildew risk

TOMATO IN PROTECTED FIELD



- Late Blight (*Phytophthora infestans*) (California model and Pessi Instruments model)
- Grey mould (*Botrytis cinerea*)
- Leaf spot (*Septoria lycopersici*)
- Anthracnose (*Colletotrichum coccodes*)
- Leaf mould (*Cladosporium fulvum*)
- Powdery mildew risk

MELON & WATERMELON, CUCUMBER, ZUCCHINI & PUMPKIN



- Downy Mildew (*Phytophthora infestans*)
- *Alternaria*
- Powdery Mildew
- Grey mould risk

PEPPER & EGGPLANT



- *Alternaria alternaria* (TomCast model)
- Root rot (*Phytophthora capsici*)
- Powdery Mildew (*Leveillula taurica*)
- Grey mould (*Botrytis cinerea*)
- Fruit rot

OLIVE



- Olive scab (*Spilocea oleagina*)
- Anthracnose

NUTS



- Walnut anthracnose (*Gnomonia leptostyla*)
- Walnut blight (*Xanthomonas arboricola* pv. *Juglandis*)
- Panicle and shoot blight
- Rust infection

ONION



- Downy Mildew (Milioncast model for *Peronospora destructor*)
- Botrytis leaf blight (*Botrytis squamosa*)
- Grey mould (*Botrytis cinerea*)
- Leaf blight (*Stemphylium vesicarium*)
- Purple blotch (*Alternaria porri*)

LETTUCE



- Downy Mildew (*Bremia lactucae*)
- Grey mould (*Botrytis cinerea*)
- Anthracnose (*Microdochium panattonianum*)



CARROT & BEET

- Carrot leaf blight (*Alternaria dauci*)
- Sugarbeet leaf spot (*Cercospora beticola*)

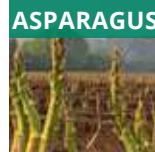

ASPARAGUS

- Purple spot (TomCast model and infection model for *Stemphylium vesicarium*)
- *Botrytis* (*B. cinerea*)
- Asparagus rust (*Puccinia asparagus*)



RICE

- Rice blast (*Magnaporthe grisea*)
- Sheath blight (*Rhizoctonia solani*)

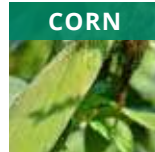

CORN

- Corn leaf blight (*Helminthosporium*, *Bipolaris*)
- Ear rot (*Fusarium* sp.)



WHEAT

- Wheat Rusts (*P. graminis*, *P. tritici*, *P. striiformis*)
- *Fusarium* head blight (with mycotoxin alert)
- Septoria diseases
- *Pyricularia grisea*
- Anthracnose
- Aphid risk



POTATO

- Potato light blight (*Phytophthora infestans*) - Prediction of risky periods for infection and NoBlight model to define further application intervals
- *Alternaria solani* (TomCast model)
- Potato black leg (Pectobacterium aerial infection)
- Potato black leg (Pectobacterium soil infection)
- Colorado beetle
- Aphid risk



For more information visit: metos.at/disease-models



INSECT MONITORING USING DEGREE DAYS/HEAT UNITS

Degree Days are used to predict insect life cycles, therefore used to target specific stages (larva, adult etc..) by insecticide treatments. Insects are exothermic ("cold-blooded") organisms, that means their development is influenced by the surrounding temperature. Accumulation of so called "Degree Days" reflects those developments.

For determination of species specific Degree Days, a minimum temperature is needed, at which the insect starts to develop at a so called "lower developmental threshold", or baseline. The maximum temperature at which insects stop developing is called the "upper developmental threshold," or cutoff. The lower and upper thresholds vary among species.

FieldClimate calculates with the input of those lower and upper developmental thresholds as well as starting date the accumulated Degree Days for each specific insect stage.

iMETOS takes frequent measurements which are continuously integrated with the temperature and give very precise information for many management decisions. Heat units, chilling units and heat portion accumulations can be used also for fruit thinning and alternance management in tree fruits. The information can also be used for planning insecticide applications or the use of biological control agents (f.e. Trichogramma applications) and for growth stages of cultivated plants (f.e. wheat, corn, sugarbeet, etc..). The tool may also be used to monitor the heating and cooling costs of buildings, while annual figures can be used for estimating future costs. More information can be found under en.wikipedia.org/wiki/Degree_day.

Lobesia botrana



Electronic trap enables remote monitoring of insect population development.

Animal Welfare

To meet the growing production demands with the increased focus on animal well-being it is crucial animal breeders constantly improve their existing practices, optimize production and improve-ensure the well-being of their animals. Early detection of stress indicators is crucial in the animal producing process and reacting at the slightest behavioural change is one of the best approaches to mitigating problems. Pessl Instruments offers solutions to cattle, swine and poultry breeders.



POULTRY

We offer extended functionality of several advanced micro-electronics devices that can be integrated into a smart cloud-based system to create audio and video based stress detection of chickens on farms, facilitating the improvement of the breeding process and to prevent chicken's health hazards.

DAIRY-CATTLE

Modern dairy cows are bred and fed for high productivity. As a result of this, the udders are a highly productive bioreactor. Along with milk, cow's highly active metabolism produces a lot of heat which must be transferred away from the cow. As a result of the need for higher productivity, the awareness of



dairy farmers to heat susceptibility of cows has increased. Optimum temperatures are in the range below 18°C. With temperatures above 24°C, significant reductions in herd productivity can be anticipated. With the help of Pessl Instruments products, all demands can be met.



SWINE

The climate in a swine pen has a decisive influence on the ability to utilize the genetic potential of your mast or breeding pigs. High relative humidity, a breeze of cold air in the building, or a cold main body will negatively influence the health of the pigs. High temperatures in the building or in the feedlot will decrease the efficiency and conversion rate of the fattening pigs.

METOS products for continuous recording of all relevant data inside the buildings and holding parameters in the feedlot will help the farmer to stay in touch with his animals remotely 24/7. Automatic alerts will be sent in real-time if a defect of the heating or cooling systems happens.

RECOMMENDED EQUIPMENT:

- **LoRATH** (see page 18)
- **LoRAIN** (see page 20)
- **iMETOS ECO D3** (see page 44)
- **CropVIEW** (see page 64)
- **iMETOS Tracker NB-IoT** (see page 70)
- **Heavy Duty multiple-temperature probe** (see page 102)

Where Can You Find Us?

HEADQUARTERS

AUSTRIA

Pessl Instruments GmbH
Werksweg 107
8160 Weiz

Tel.: +43 (0) 3172 5521
Fax: +43 (0) 3172 5521 23
email: office@metos.at

AGRI[®]PRECISION

MOROCCO

Lahsen Ait El Moueddane
Agri Precision
+212 522 254 900
agriprecision@gmail.com

METOS[®]ANZ

AUSTRALIA & NEW ZEALAND

Sam Eyres
METOS - Australia & NZ
+61 0407 534 559
sam.eyres@metos.com.au

aquagri

PORTUGAL

Onno Schaap
Aquagri IIM
+351 21 466 0773
onnoschaap@aquagri.com

METOS[®]BRASIL

BRASIL

Luciano Loman
METOS Brasil Importação e Exportação Ltda.
+55 (11) 3380-1022 / +55 (11) 98350-0003
brasil@metos.at

METOS[®]CANADA

CANADA

Guy Ash
+1 204 229 6139
guy.ash@metos.at

METOS[®]FRANCE

FRANCE & BELGIUM

Erik Bijwaard
METOS France
+43 664 2311 003
erik.bijwaard@metos.at

METOS[®]HUNGARY

HUNGARY

Annabella Szabó
METOS Magyarország Kft.
+36 30 724 2124
annabella.szabo@metos.at

METOS[®]IBERIA

SPAIN

Álvaro Velasco Gutiérrez
METOS Iberia SA
+34 689 182 587
alvaro.velasco@metos.at

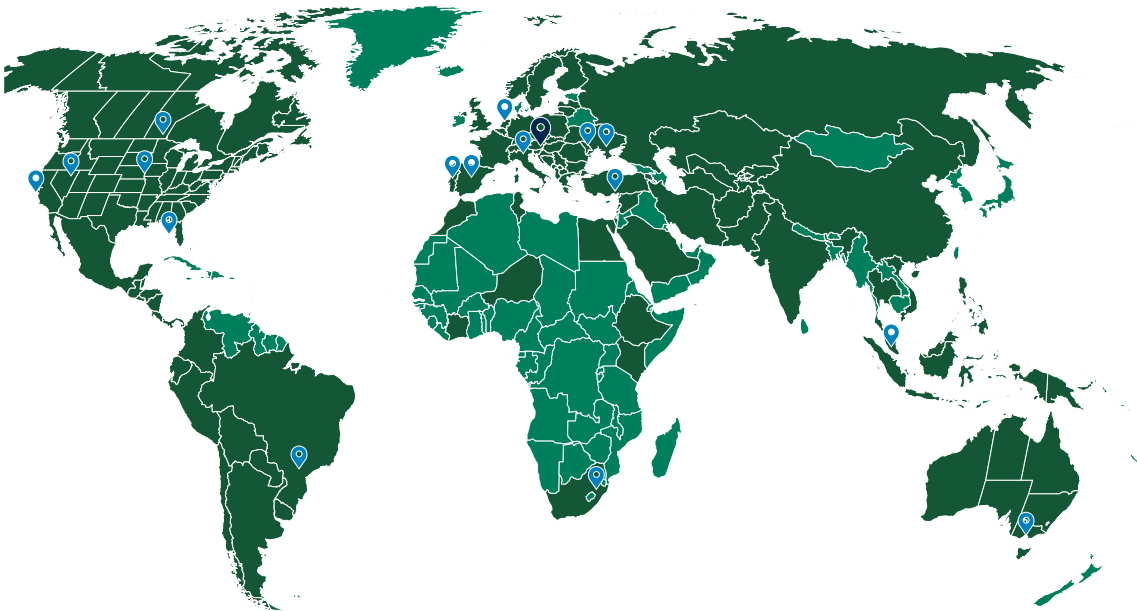

-  Branch offices
-  Countries covered by distributors

ITALY**ITALY**

Federico Fantin
+39 327 6738804
federico.fantin@metos.at

METOS® LATAM**SOUTH AMERICA**

Yonathan Rivas
METOS LATAM
+55 11 97592 9386
yonathan.rivas@metos.at

METOS® SOUTH AFRICA**SOUTH AFRICA**

Marius Boshoff
+27 81 450 5380
mboshoff@villacrop.co.za

METOS® SOUTH-EAST ASIA**SOUTH-EAST ASIA**

Vishnu Nair
METOS Asia
+6012 6456 100
vishnu@metos.asia

METOS® MOLDOVA**MOLDOVA**

Sergiu Smocinski
iMETOS SRL
+37 368 151 515
sergiu.smocinski@metos.at

METOS® MX**MEXICO**

Enrique Audiffred
Agrotecnologia de America, S.A. de C.V.
+52 452 523 4068 / +52 452 149 2300
enriqueav@metos.at

METOS® TURKEY**TURKEY**

Fikriye Berk
METOS TR
+90 324 221 96 74
info@metos.com.tr

METOS® UK**UNITED KINGDOM**

David Whattoff
METOS UK LTD
07752 426006
david.whattoff@metos.at

METOS® POLSKA**POLAND**

Marek Januszewski
Metos Polska Sp. z o.o.
+48 733 601 690
marek.januszewski@metos.at

METOS® RUSSIA**RUSSIA**

Vladimir Mikolaevskii
+7 921 616 35 25
vladimir.mikolaevskii@metos.at

Dmitry Nikiforov
+7 903 141 20 36
dmitry.nikiforov@metos.at

METOS® UKRAINE**UKRAINE**

Sergey Kovalenko
METOS Ukraine, LLC
+38 050 494 3422
sergey.kovalenko@metos.at

METOS® USA**USA**

Petru Stratan
METOS USA
+1 559 753 0490
petru.stratan@metos.at

If you look for local dealers of countries not listed please refer to our webpage www.metos.at or contact our headquarters.



WWW.METOS.AT



Values may be changed without prior notice. All rights reserved. Copyright Pessl Instruments GmbH

Pessl Instruments GmbH, Werksweg 107, 8160 Weiz
Tel: +43 (0) 3172 5521 • Fax: +43 (0) 3172 5521 23 • Email: office@metos.at